



Installation Instructions Duster

Vehicle Application:
Jeep® JL Wrangler Unlimited 2018-Current
Part Number 90036 (Requires #52700-01 with Optional #52603-01)

Installation Tips

Before you begin installing your new Duster, please read all the instructions thoroughly.





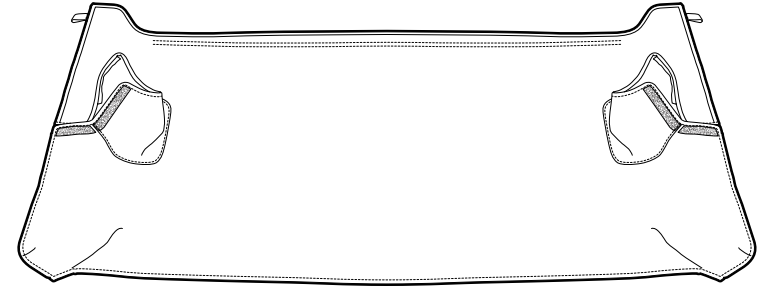



WARNING Do not rely in any way on the components of this product to protect against injury or death in the event of an accident. Never operate the vehicle in excess of manufacturer’s specifications.

Read and follow, precisely, all installation instructions provided when installing this product. Failure to do so may result in a poor fit and could place occupants of the vehicle in a potentially dangerous situation.



WEAR SEAT BELTS AT ALL TIMES

CAUTION Safety glasses should be worn at all times when installing this product.

Tools	Installation Time	Support
 Safety Glasses  T40 - T50 Torx Wrenches (included in your Jeep tool kit)	 30 minutes Skill Level     1 - Easy	We're here to help! Go to: https://www.bestop.com and click on Need Help?  https://www.bestop.com/video-library



Installation Instructions Duster

Vehicle Application:
Jeep® JL Wrangler Unlimited 2018-Current
Part Number 90036 (Requires #52700-01 with Optional #52603-01)

Sugerencias de Instalación

Antes de empezar a instalar esta unidad, lea atentamente todas las instrucciones.

Para un buen ajuste:

Para facilitar la instalación, el producto debe instalarse a temperaturas superiores a 72 °F (22 °C).

Por debajo de esta temperatura, la tela puede encogerse una pulgada o más, lo que dificultaría su ajuste al vehículo.

Es normal que la tela se contraiga o arrugue cuando está guardada en la caja de empaque. A los pocos días después de la instalación, la tela se relajará y las arrugas desaparecerán.



ADVERTENCIA

Este producto se diseñó principalmente para mejorar la apariencia del vehículo y proteger a los ocupantes de las condiciones climáticas comunes. De ninguna manera piense que los componentes de este producto pueden servir como medio de contención para los ocupantes del vehículo o que pueden protegerlos contra lesiones o la muerte en caso de accidente. Este producto no protegerá a los ocupantes contra caídas de objetos. Nunca conduzca este vehículo fuera de las especificaciones del fabricante.

USE LOS CINTURONES DE SEGURIDAD EN TODO MOMENTO

Lea y siga con precisión todas las instrucciones de instalación que se proporcionan para instalar este producto. Si no lo hace, podría producirse un mal ajuste que colocaría a los ocupantes del vehículo en una situación potencialmente peligrosa.



PRECAUCIÓN

Debe usar gafas protectoras en todo momento durante la instalación de este producto.

Conseils pour l'installation

Lire toutes les instructions au complet avant de commencer l'installation de cet assemblage.

Pour un ajustement sans problème :

Afin de faciliter l'installation, ce produit doit être installé à des températures au-dessus de 72 °F (22 °C).

Sous cette température, le tissu peut rétrécir d'un pouce (2,5 cm) ou plus, ce qui rendra l'ajustement sur le véhicule difficile.

Il est normal que le tissu rétrécisse et plisse pendant qu'il est dans la boîte d'expédition. En quelques jours après l'installation, le tissu se détendra et les plis disparaîtront.



AVERTISSEMENT

Ce produit est conçu principalement pour améliorer l'apparence du véhicule et pour protéger les occupants des conditions météorologiques usuelles. Ne jamais se fier aux composants de ce produit pour se protéger de blessures ou de la mort en cas d'accident. Ce produit ne protégera pas les occupants des chutes d'objets. Ne jamais utiliser le véhicule au-delà des caractéristiques techniques indiquées par le fabricant.

PORTER UNE CEINTURE DE SÉCURITÉ EN TOUT TEMPS

Lire et suivre, très fidèlement, toutes les instructions d'installation fournies lors de l'installation de ce produit. Ne pas suivre cette consigne peut causer une installation inadéquate et mettre les occupants du véhicule dans une situation potentiellement dangereuse.



MISE EN GARDE

Des lunettes de sécurité doivent être portées en tout temps lors de l'installation de ce produit.



Installation Instructions Duster

Vehicle Application:
Jeep® JL Wrangler Unlimited 2018-Current
Part Number 90036 (Requires #52700-01 with Optional #52603-01)

Parts List

- Required parts for installation - Page number in Installation Guide

Sections 1 to 6 Duster, End Caps, Tailgate Bar & Retainers

Pages 4 to 9 of Guide

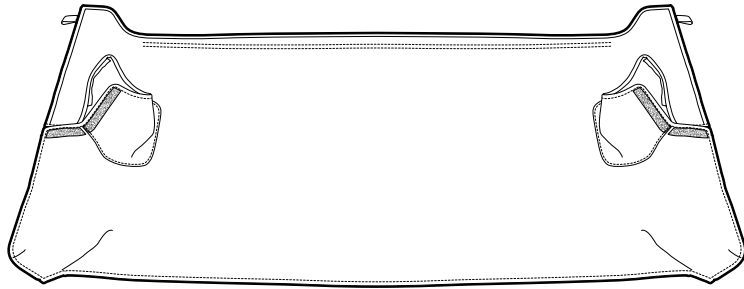

Duster
Qty. 1

Optional Parts, available separately in the Bestop #52603-01 Parts Kit.

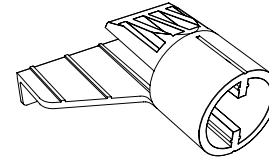

Plastic End Cap - Left
Bestop Part #593.71
Qty. 1

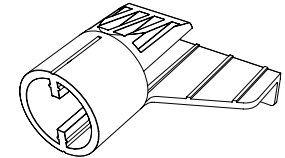

Plastic End Cap - Right
Bestop Part #592.66
Qty. 1

Required Parts, available separately in the Bestop #52700-01 Parts Kit.

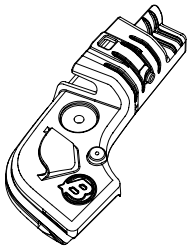

Tailgate Bar Retainer
Part #575.38 - Right (shown)
Part #575.39 - Left
Qty. 1 of each

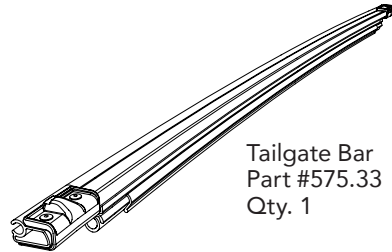

Tailgate Bar
Part #575.33
Qty. 1

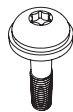

M8 x 1.25 x 38
Button Head
Socket Cap Screw
#532.17
Qty. 2

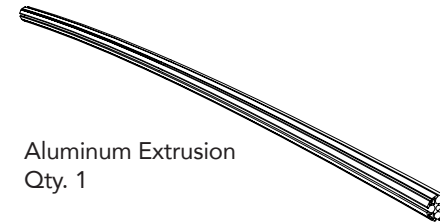

Aluminum Extrusion
Qty. 1

Step 1

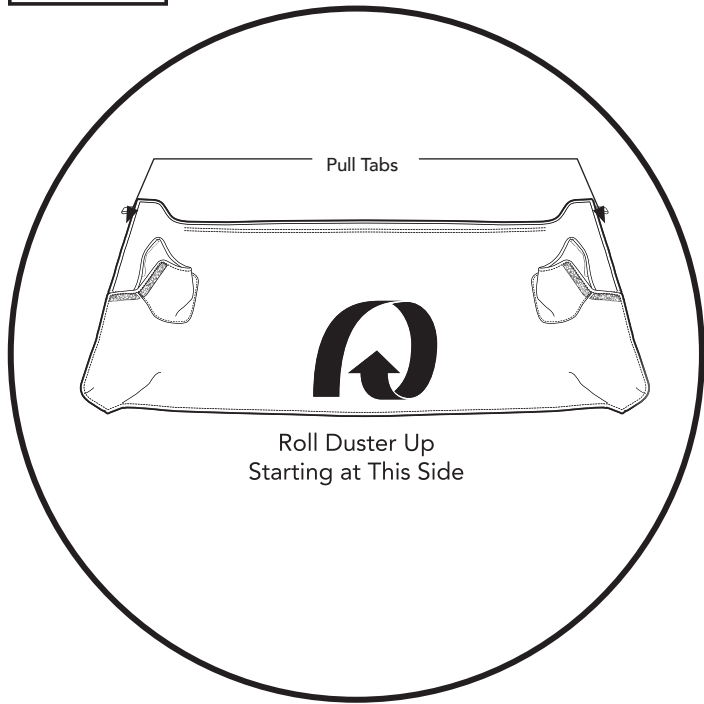

Step 1

Starting on the side of the duster without the pull tabs, roll the Duster up loosely.

The side of the Duster with the pull tabs is the front edge.

Hardware

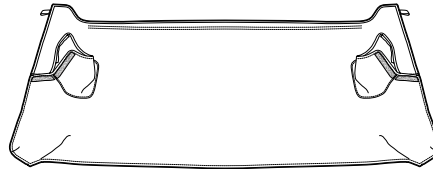

Duster Qty. 1

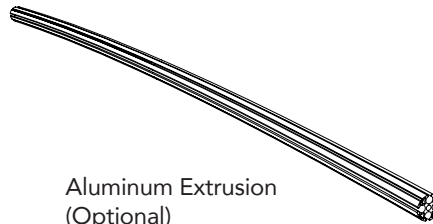

Aluminum Extrusion (Optional) Qty. 1 Sold Separately in Bestop #52603-01 Kit

Step 2

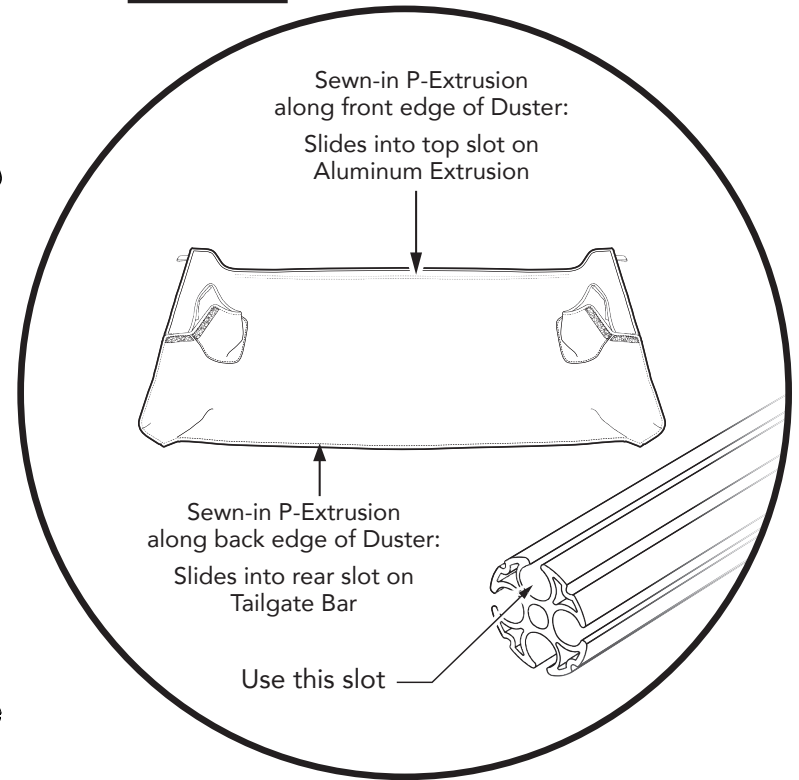

Step 2

With the Duster loosely rolled up, slide the P-Extrusion along the exposed front edge of the Duster into the top slot of the Extruded Aluminum Bow, using the slot in the Bow that is on top of the arch and facing up.

Step 1 593.71 592.66

Hardware 52603-01 Parts Kit

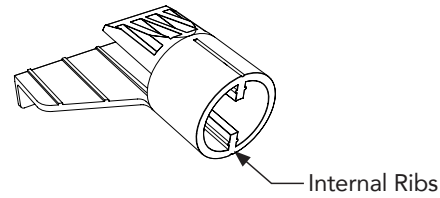
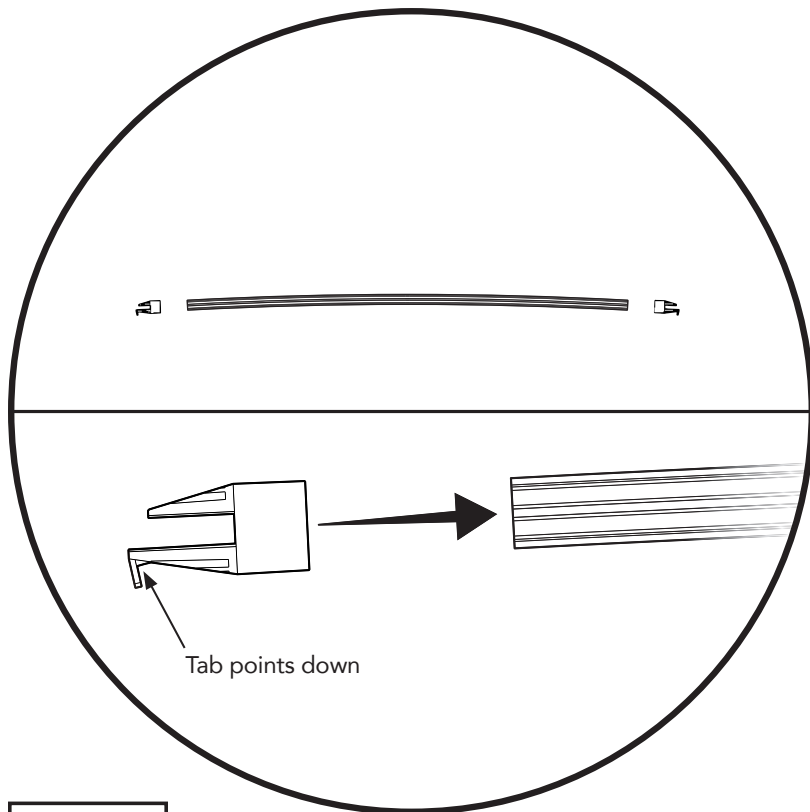

Plastic End Cap - Left
(Optional)
Bestop Part #593.71
Qty. 1
Sold Separately

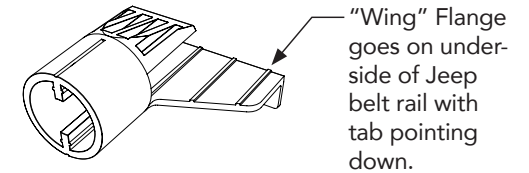

Plastic End Cap - Right
(Optional)
Bestop Part #592.66
Qty. 1
Sold Separately

Step 1

Place the Plastic End Caps #593.71 and #592.66 on the Extruded Aluminum Bow (Available separately with Bestop Parts Kit #52603-01).

The Caps should be aligned so that the "wing" flange is on the underside of the Jeep belt rail, and the tab on each flange is pointing down.

The internal ribs inside the round opening of each end cap will slide into the slots on the top and bottom of the aluminum extrusion.

Step 1

Tools

Step 2

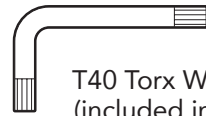
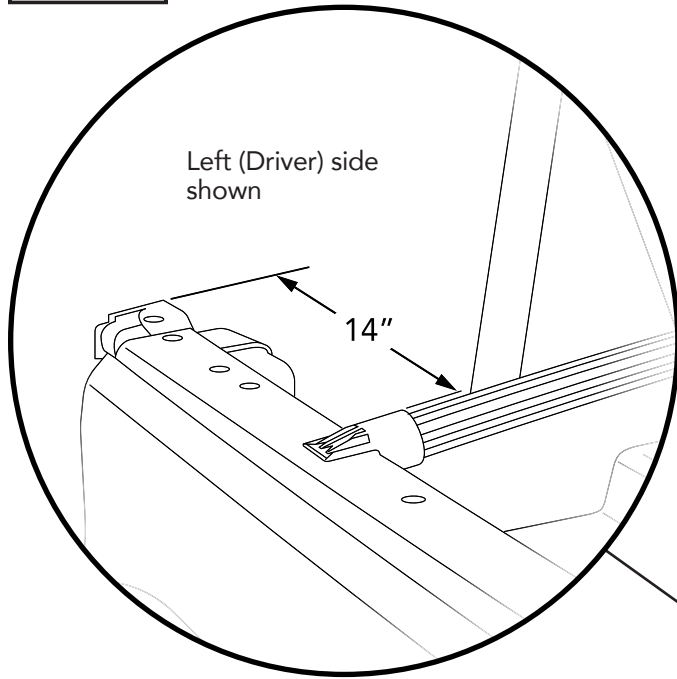

T40 Torx Wrench
(included in your
Jeep tool kit)

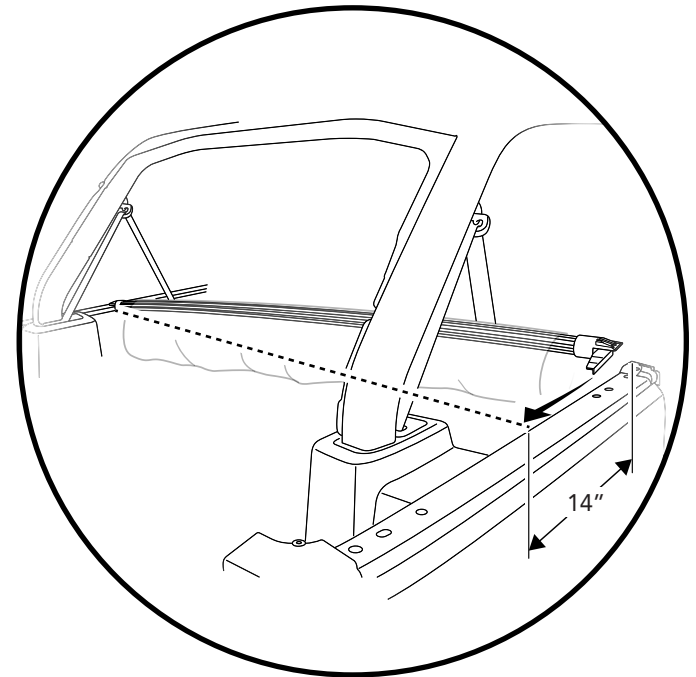

Step 1

Slide the open end of one end cap with attached aluminum extrusion over the Jeep belt rail at a location 14.75" from the plastic trim cap at the rear of the door opening.

Step 2

Now pivot the other end of the aluminum bow with attached end cap into place. Slide the opening of the end cap over the Jeep belt rail, and locate it the same distance - 14" - from the door opening trim cap on the same side.

NOTE: If you have Door Surrounds on your vehicle, you must remove some fasteners to allow the Door Surround to be moved out of the way before pivoting the Extrusion Bow into place. You do not need to remove the Door Surround - just move it out of the way. Use the T40 Torx Driver that comes in your Jeep's tool kit to remove the Door Surround fasteners.



Step 1	575.38	575.39	532.17
---------------	--------	--------	--------

Hardware	52700-01 Parts Kit
-----------------	--------------------

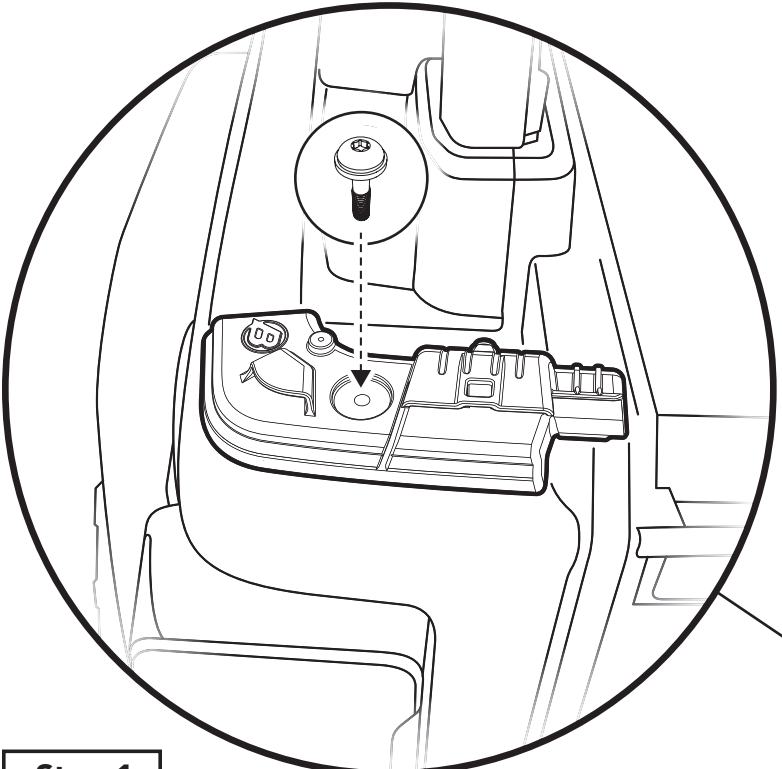

Tailgate Bar Retainer
Part #575.38 - Right
Qty. 1

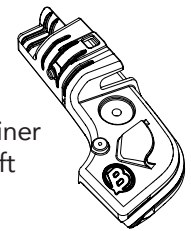

Tailgate Bar Retainer
Part #575.39 - Left
Qty. 1

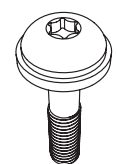

M8x1.25x38
Button Head
Socket Cap Screw
#532.17
Qty. 2

Tools

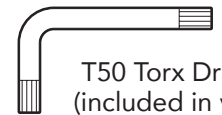

T50 Torx Driver
(included in your
Jeep tool kit)

Step 1

Attach the Tailgate Bar Retainers #575.38 (right) and #575.39 (left) to the Jeep Belt Rail, using one (1) M8x1.25x38 Button Head Socket Cap Screw #532.17 per retainer.

Insert the screws through the retainers, and into threaded holes in the top of the Jeep belt rail, and tighten.



Step 1

Hardware

52700-01 Parts Kit

Step 2

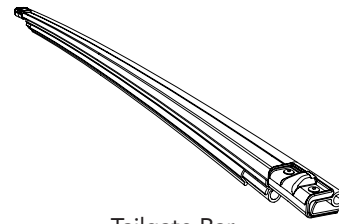
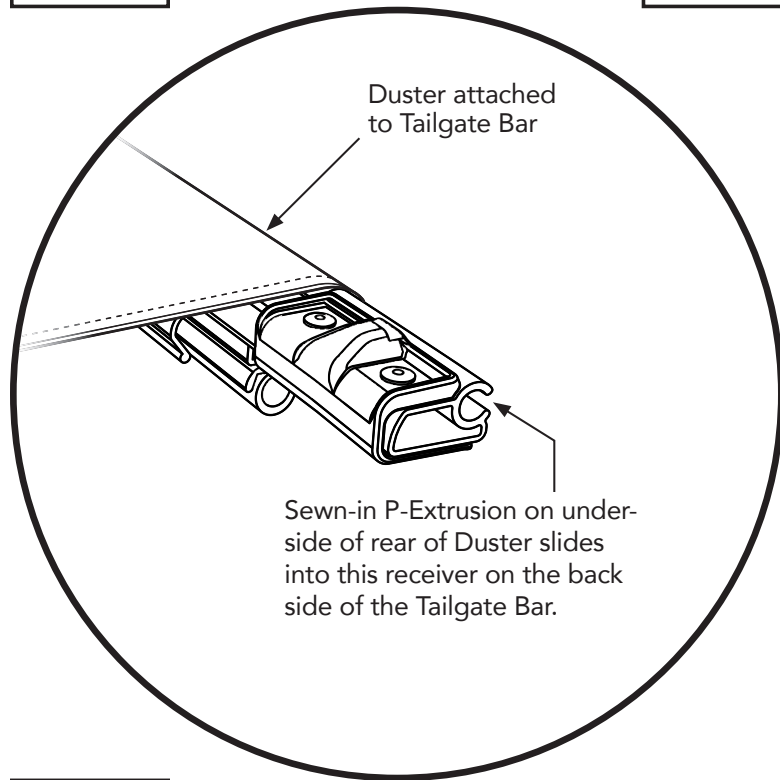

Tailgate Bar
#575.33
Qty. 1

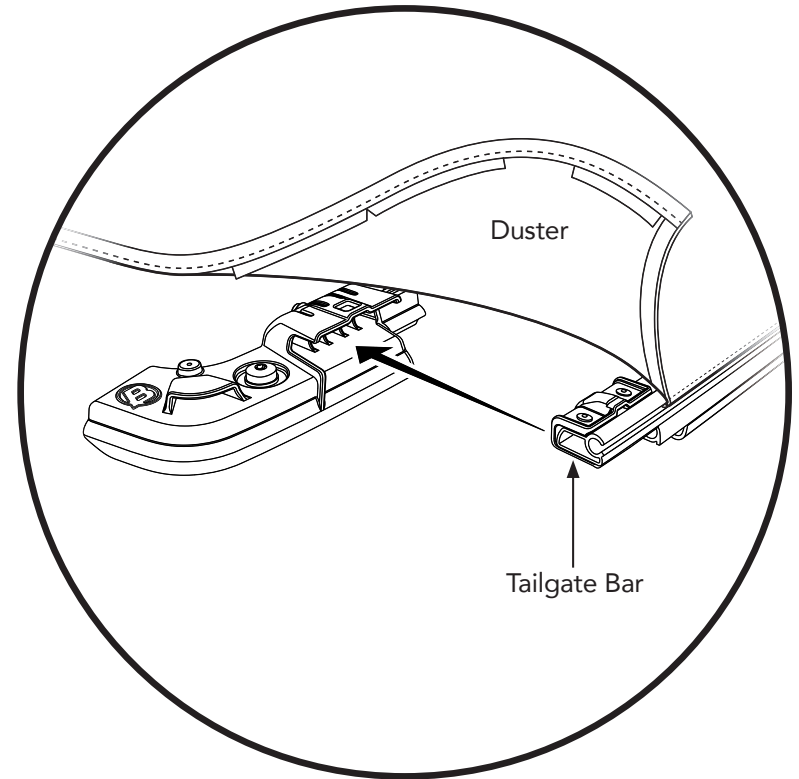

Step 1

Attach the Tailgate Bar #575.33 (from #52700-01 Parts Kit) to the sewn-in P-Extrusion rail on the underside of the rear of the Duster.

Slide the Tailgate Bar all the way across.

Step 2

Secure the Tailgate Bar with attached Duster to the Tailgate Bar Retainers that you installed in Section 4.

Press the Tailgate Bar into the receiver on each Tailgate Bar Retainer.

Step 1

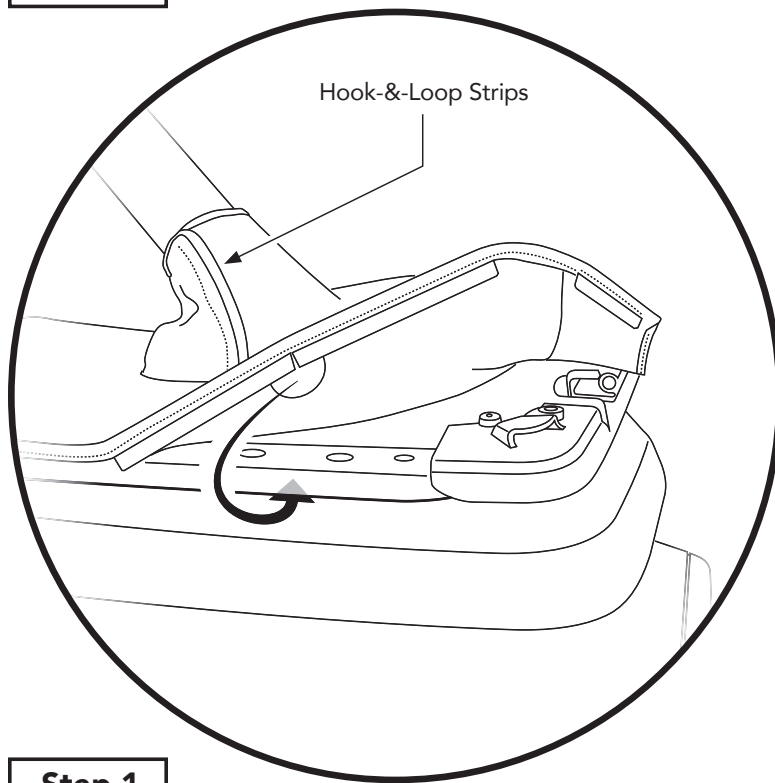

Tools



T40 Torx Wrench
(included in your
Jeep tool kit)

Step 1

Tuck the plastic tabs along the left and right edges of the Duster underneath the Jeep belt rail, working from back to front.

Make sure to tuck the straight tabs as well as the semi-circular tabs under the belt rail.

Tuck all side plastic tabs under the belt rail, from back to front, and then tuck the plastic tabs at the rear corners under the belt rail.

Wrap the hook-&-loop sleeves around the sport bar downtubes, and attach hook-&-loop strips together snugly.

You may now return the Door Rail that you moved in Section 3 back into place and tighten the fasteners.



Warranty Information Duster

Vehicle Application:
Jeep® JL Wrangler Unlimited 2018-Current
Part Number 90036 (Requires #52700-01 with Optional #52603-01)

WHAT BESTOP WARRANTS

Subject to the terms and conditions of sale, including any terms and conditions set forth by Bestop, Inc. (“Bestop” or “us” or “we”) in our then-current terms of sale on our website (collectively, the “Terms”), Bestop represents and warrants that: the covered products listed in the “Covered Products and Warranty Periods” section (a “Product”) will substantially be free from defects in materials and workmanship for the specified warranty periods set forth in that section.

THE WARRANTY IS LIMITED AND CONDITIONAL

This warranty applies to the original purchaser of the Product only. The warranty is valid only as long as the original retail purchaser owns the vehicle upon which the Product is installed. The warranty expires should the Product be removed from the original vehicle or if the original vehicle is transferred to another owner.

This warranty is not transferable or assignable. The warranty does not apply to Product bought from auction-style or price-bid websites.

THE LIMITED WARRANTY AND STATED REMEDIES ARE SOLE AND EXCLUSIVE AND IN LIEU OF ALL OTHER WARRANTIES AND REMEDIES, AND COMPANY EXPRESSLY DISCLAIMS ALL IMPLIED OR STATUTORY OR OTHER WARRANTIES, INCLUDING WITHOUT LIMITATIONS WARRANTIES OF MERCHANTABILITY, NON-INFRINGEMENT OR FITNESS FOR A PARTICULAR PURPOSE. IN NO EVENT WILL COMPANY BE LIABLE FOR ANY SPECIAL, INCIDENTAL, CONSEQUENTIAL, PUNITIVE, INDIRECT OR EXEMPLARY DAMAGES OF ANY KIND, INCLUDING LOST PROFITS OR REVENUE, HOWEVER CAUSED, WHETHER FOR BREACH OR REPUDIATION OF CONTRACT, TORT, BREACH OF WARRANTY, NEGLIGENCE, OR OTHERWISE, WHETHER OR NOT COMPANY WAS ADVISED OF THE POSSIBILITY OF SUCH LOSS OR DAMAGES.

Some states do not allow exclusion or limitation, so this may not apply to you. This warranty gives you specific legal rights, and you may have other rights which vary from state to state.

EXCLUSIONS TO THE WARRANTY

The Limited Warranty excludes, and Bestop is not liable in any way for any warranty claims, damages, or defects related to:

- Misuse, abuse, accidents, vandalism, negligence, fire, or improper installation or modification, or improper or inadequate maintenance;
- Failure to comply with any Product documentation, Bestop instructions, or applicable law or regulations; use in extreme conditions
- Force Majeure including but not limited to, earthquake, hurricane, tornado, flooding, or other disasters natural or man-made, civil unrest, strikes, declared or undeclared war, or lack of performance by, or discontinued product of, supply chain partners whose products, software, operations or management is beyond the control of Bestop;
- Damage resulting in breakage (including without limitation, spontaneous breakage, accidental breakage or breakage by any other means) of a Product or any component part;
- Damage to vinyl windows due to misuse, or cracking due to varying weather conditions.

YOUR SOLE REMEDY

During the applicable warranty period, Bestop shall, at its option, either repair or replace any Product that it confirms, in its discretion, is non-compliant with the warranties herein. Bestop will not pay for labor charges associated with installation or removal of the Product. Should a specific Product be discontinued, Bestop may, at its option, replace the discontinued Product with a current product or like product.

Please retain your proof of purchase. Original proof of purchase for the Product must accompany any warranty claim. If you have a warranty claim, first you must email Bestop Customer Service at csbestop@bestop.com for instructions. All claims must be emailed to csbestop@bestop.com within 30 days of discovery of a defective Product, but in no event later than thirty days after the end of the applicable Warranty Period (the “Warranty Notice Period”). Warranty claims made after the Warranty Notice Period are null and void and Bestop shall have no responsibility with respect to such claims.

THIS SECTION SETS FORTH BESTOP’S SOLE OBLIGATION & YOUR SOLE REMEDY WITH RESPECT TO ANY DEFECTS OR OTHER PRODUCT ISSUE. ANY PRODUCTS REPLACED UNDER TERMS OF THIS WARRANTY WILL BE COVERED UNDER TERMS & BALANCE OF THE DURATION OF THE ORIGINAL LIMITED WARRANTY FOR SUCH PRODUCT.



Warranty Information Duster

Vehicle Application:
Jeep® JL Wrangler Unlimited 2018-Current
Part Number 90036 (Requires #52700-01 with Optional #52603-01)

COVERED PRODUCTS AND WARRANTY PERIODS: The warranty time periods are as follows for Products manufactured by Bestop:

BESTOP® LIMITED LIFETIME WARRANTY

Trektop® Pro Twill Fabric Top Sunrider® for Hardtop Twill Fabric Top
Trektop® NX Glide Twill Fabric Top Replace-a-Top™ Twill Fabric Top
Trektop® NX Twill Fabric Top Supertop® NX Twill Fabric Top
EZFold™ Soft Tonneaus Floor & Cargo Liners
ZipRail™ Soft Tonneaus Pet Barriers
EZRoll™ Soft Tonneaus

BESTOP® 5-YEAR LIMITED WARRANTY

Trektop® NX Glide™ Top (non-Twill) Sunrider® for Hardtop (non-Twill) Replace-a-Top™ Top (non-Twill) Trektop® NX Top (non-Twill)
Sailcloth Replace-a-Top™ Supertop® NX Top (non-Twill)
Tigertop™ and Halftop™ Supertop® Classic Soft Top Sunrider® Complete Soft Top Supertop® for Truck
EZ Fold Hard Tonneau

BESTOP® 3-YEAR/100K MILES LIMITED WARRANTY

Powerboard® & Powerboard® NX
Trekstep®, Side Mount
Trekstep®, Rear Mount

BESTOP® 3-YEAR LIMITED WARRANTY

Pavement Ends Sprint Top

BESTOP® 2-YEAR LIMITED WARRANTY

Trektop® Classic Soft Top
RoughRider™ Soft Storage

BESTOP® 1-YEAR LIMITED WARRANTY

All other Bestop® & Pavement Ends™ products not specified above.

For further information or request for warranty work, please contact:

Bestop Inc. Customer Service
Toll-Free: (800)845-3567
Main: (303)465-1755
E-mail: csbestop@Bestop.com
Website: www.Bestop.com