







# Installation Instructions

## KNOCK DOWN INSTATRUNK™

### Vehicle Application:

- Jeep® Wrangler  
1986 – 1995  
Part Number: 42700

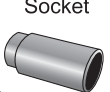
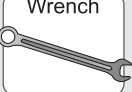
[www.Bestop.com](http://www.Bestop.com) - We're here to help! Visit our web site and click on "[Ask a Question](#)". Click here for more [Jeep® Accessories by Bestop](#).

INSTALLATION TIME	SKILL LEVEL			
 <b>3/4 Hour</b>	<b>1</b> <b>2</b> <b>3</b> <b>4</b> <b>1 - Easy</b>			
TOOLS				
 Phillips Screwdriver	 Socket M13 and 9mm	 Wrench M13	 Ratchet	 Safety Glasses



**! WARNING** This product is designed primarily to enhance the appearance of the vehicle. Do not rely in any way on the components of this product to protect against injury or death in the event of an accident. Never operate the vehicle in excess of manufacturer's specifications.

### WEAR SEAT BELTS AT ALL TIMES

Read and follow, precisely, all installation instructions provided when installing product. Failure to do so may result in a poor fit and could place occupants of the vehicle in a potentially dangerous situation.

# KNOCK DOWN INSTATRUNK™ Installation Instructions

## Parts List

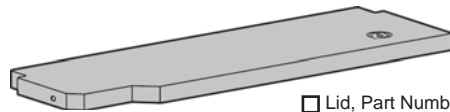

□ Lid, Part Number 494.97, Qty - 1

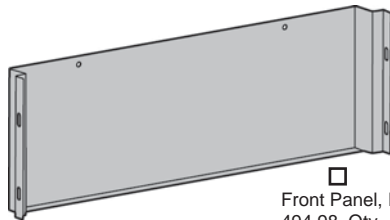

□ Front Panel, Part Number 494.98, Qty - 1

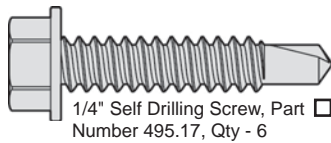

□ 1/4" Self Drilling Screw, Part Number 495.17, Qty - 6

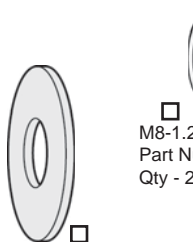

□ M10 Flat Washer, Part Number 481.58, Qty - 2

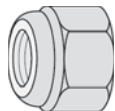

□ M8-1.25 Hex Lock Nut, Part Number 434.12, Qty - 2

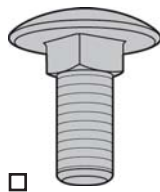

□ M8-1.25 x 20mm Carriage Bolt, Part Number 497.58, Qty - 2

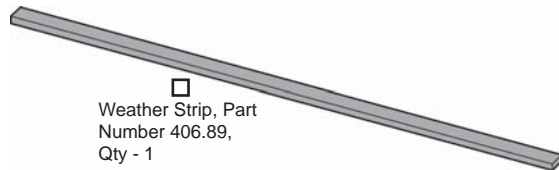

□ Weather Strip, Part Number 406.89, Qty - 1

## 1 Assemble INSTATRUNK™

Use the M8-1.25 x 20mm Carriage Bolts, M10 Flat Washers and M8-1.25 Hex Lock Nuts to assemble the Lid to the Front Panel.

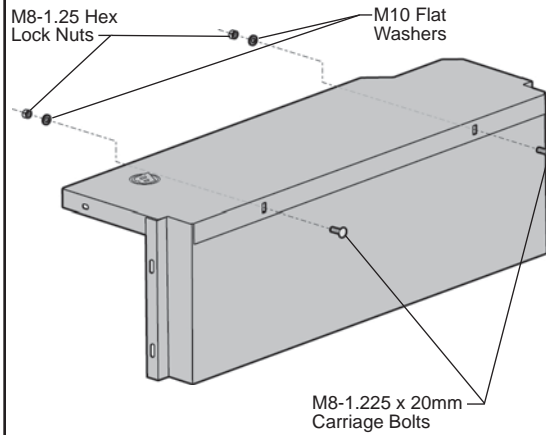

M8-1.25 Hex Lock Nuts

M10 Flat Washers

M8-1.225 x 20mm Carriage Bolts

## 2 Install Weather Strip

Locate the Weather Strip in the parts kit. From the rear of the trunk, start installing the Weather Strip along the rear edge so that it will form a seal between the Instatrunk™ and the tailgate. Start on the driver's side and work across to the passenger's side. Peel the backing off the Weather Strip a few inches at a time and press the adhesive on the Weather Strip onto the edge of the trunk.

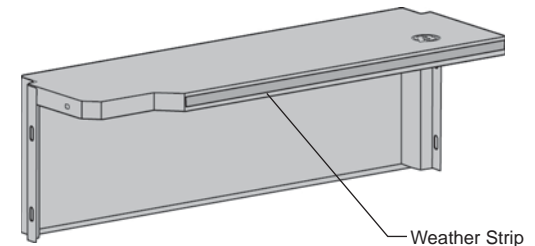

Weather Strip

## Knock Down INSTATRUNK™ Installation Instructions

### 3 Install INSTATRUNK™

Open the tailgate of the vehicle and lean the rear seat back forward.

Place the Instatrunk™ in the vehicle so that it fits snugly between the wheel wells with the top level with the top of the wheel wells and with the notches around the plastic seat belt covers. Make sure that the contoured edge of the trunk with the Weather Strip is flush against the tailgate. Close the tailgate to check that the Weather Strip forms a seal against the tailgate. Adjust the position of the trunk as needed.

**NOTE** In some cases there may be extra padding under the carpet, in this case it may be necessary to remove it for the Instatrunk™ to fit properly.

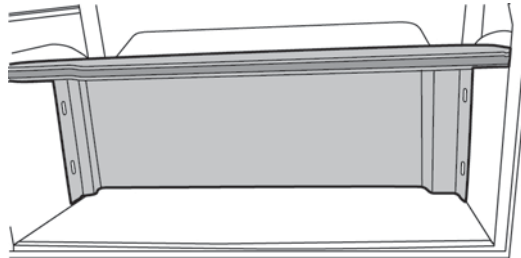

### CAUTION

Do not drill into the floor of your vehicle. The Instatrunk™ must be securely installed in the vehicle during vehicle operation.

### 4 Secure INSTATRUNK™

Locate the six pre-drilled holes in the INSTATRUNK™. Install a 1/4" Self Drilling Screw at each location.

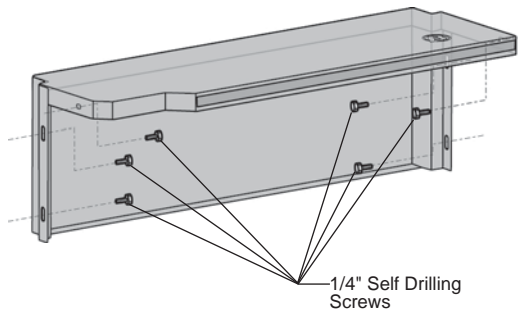

### NOTE

To use the rear seat, use the lever in front of the seat back on the driver's side.

## **KNOCK DOWN INSTATRUNK™ Installation Instructions**

---

### **LIMITED WARRANTY**

We warrant our product to be free from defects in material and workmanship, for the terms specified below, provided there has been normal use and proper maintenance. This warranty applies to the original purchaser only. All remedies under this warranty are limited to the repair or replacement of any item or items found by the factory to be defective within the time period specified. If you have a warranty claim, first you must call our factory at the number below for instructions. You must retain proof of purchase and submit a copy with any items returned for warranty work. Upon completion of warranty work, if any, we will return the repaired or replaced item or items to you freight prepaid. Damage to our products caused by accidents, fire, vandalism, negligence, misinstallation, misuse, Acts of God, or by defective parts not manufactured by us, is not covered under this warranty.

THE WARRANTY TIME PERIOD IS AS FOLLOWS FOR REPLACE-A-TOP™, SAILCLOTH REPLACE-A-TOP™, SUPERTOP®, SUPERTOP® REPLACEMENT SKINS, SUNRIDER®, AND TIGERTOP®: TWO YEARS FROM DATE OF PURCHASE.

THE WARRANTY TIME PERIOD IS AS FOLLOWS FOR ALL OTHER “SOFT GOODS” MANUFACTURED BY OUR COMPANY (USING PRIMARILY VINYL, PLASTICS, AND/OR FOAM): ONE YEAR FROM DATE OF PURCHASE.

THE WARRANTY TIME PERIOD IS AS FOLLOWS FOR ALL OTHER “HARD GOODS” MANUFACTURED BY OUR COMPANY (USING PRIMARILY METALS, PLASTICS, AND/OR FIBERGLASS): ONE YEAR FROM DATE OF PURCHASE.

ANY IMPLIED WARRANTIES OF MERCHANTABILITY AND/OR FITNESS FOR A PARTICULAR PURPOSE CREATED HEREBY ARE LIMITED IN DURATION TO THE SAME DURATION AND SCOPE AS THE EXPRESS WRITTEN WARRANTY. OUR COMPANY SHALL NOT BE LIABLE FOR ANY INCIDENTAL OR CONSEQUENTIAL DAMAGE.

Some states do not allow limitations on how long an implied warranty lasts, or the exclusion or limitation of incidental or consequential damages, so the above limitations or exclusions may not apply to you. This warranty gives you specific legal rights, and you may also have other rights which vary from state to state.



For further information or request for warranty work, please contact:  
Bestop Inc. Customer Service  
Toll-Free: (800)845-3567  
Main: (303)465-1755  
E-mail: [csbestop@Bestop.com](mailto:csbestop@Bestop.com)  
Website: [www.Bestop.com](http://www.Bestop.com)