



Installation Instructions Seat Covers, Front Kit

Vehicle Application:
Wrangler 2DR, Wrangler Unlimited
2007-2012
Part Number 29280

Installation Tips

Read and follow, precisely, all installation instructions provided when installing this product. Failure to do so may result in a poor fit, and could place occupants of the vehicle in a potentially dangerous situation.





WARNING

To reduce the risk of accidental injury: Follow all vehicle Manufacturer's and Bestop® safety messages, application and installation instructions.

- Do not remove seats from the vehicle to install this product.
- Fit and maintain sides of seat cover as tight to seat as possible, always matching front to side seam of seat with similar panels and seams of seat cover.
- Remove headrest carefully to avoid damaging manufacturer's wiring. Assure all plugs are connected after installation of seat cover.
- Do not use and replace if seat cover becomes damaged or wear no longer allows tight fit to seat sides.



WEAR SEAT BELTS AT ALL TIMES

Tools	Installation Time	Support
 Safety Glasses  CAUTION Safety glasses should be worn at all times when installing this product.	 2 Hours Skill Level  3 - Moderately Difficult	We're here to help! Go to www.Bestop.com and click "Contact Us"  See a video showing installation of this product at: www.bestop.com/video



Installation Instructions



Seat Covers, Front Kit

Vehicle Application:
Wrangler 2DR, Wrangler Unlimited
2007-2012
Part Number 29280

Parts List

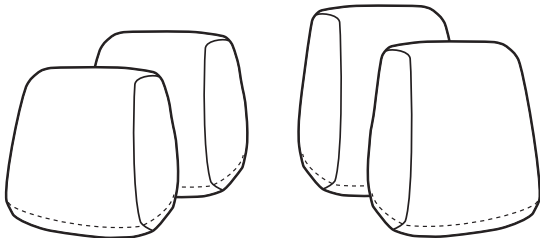
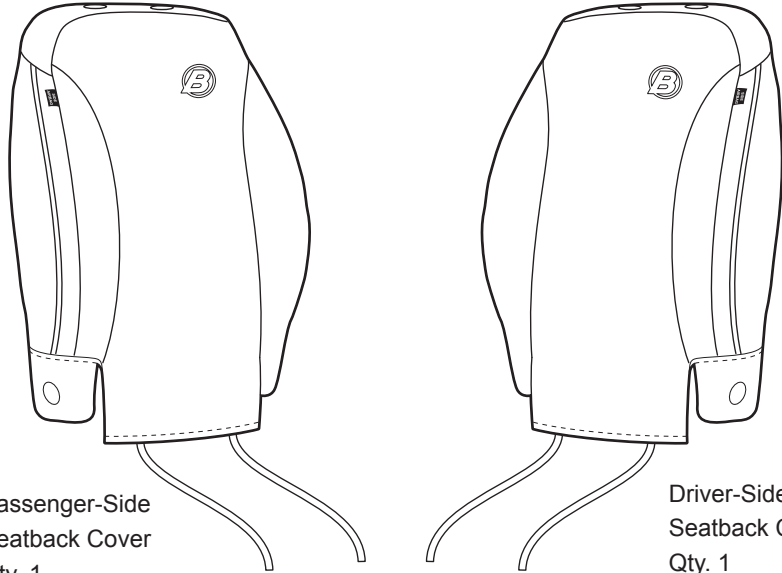
- Required parts for each installation section - Page number in Installation Guide

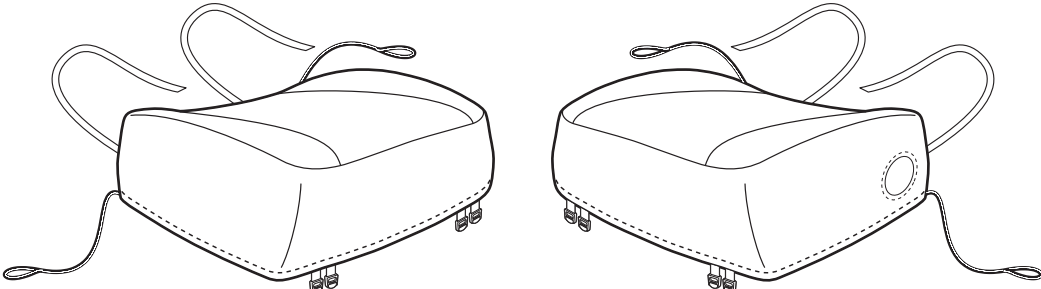
Section 1	Headrest Covers	Page 3	Section 2	Seatback Covers	Page 4-7
 <p data-bbox="247 716 388 776">2007-2010 Vinyl Covers</p> <p data-bbox="457 727 514 760">OR</p> <p data-bbox="590 716 730 776">2011-2012 Cloth Covers</p> <p data-bbox="396 898 579 958">Headrest Covers Qty. 2 sets of 2</p>			 <p data-bbox="1035 883 1209 979">Passenger-Side Seatback Cover Qty. 1</p> <p data-bbox="1719 873 1894 969">Driver-Side Seatback Cover Qty. 1</p>		

Section 3	Seat Bottom Covers	Page 8
 <p data-bbox="174 1419 384 1515">Passenger-Side Seat-Bottom Cover Qty. 1</p> <p data-bbox="737 1412 945 1508">Driver-Side Seat-Bottom Cover Qty. 1</p>		 <p data-bbox="1591 1258 1827 1354">Seat Bottom Elastic Cord S-hooks Qty. 2</p>

Step 1

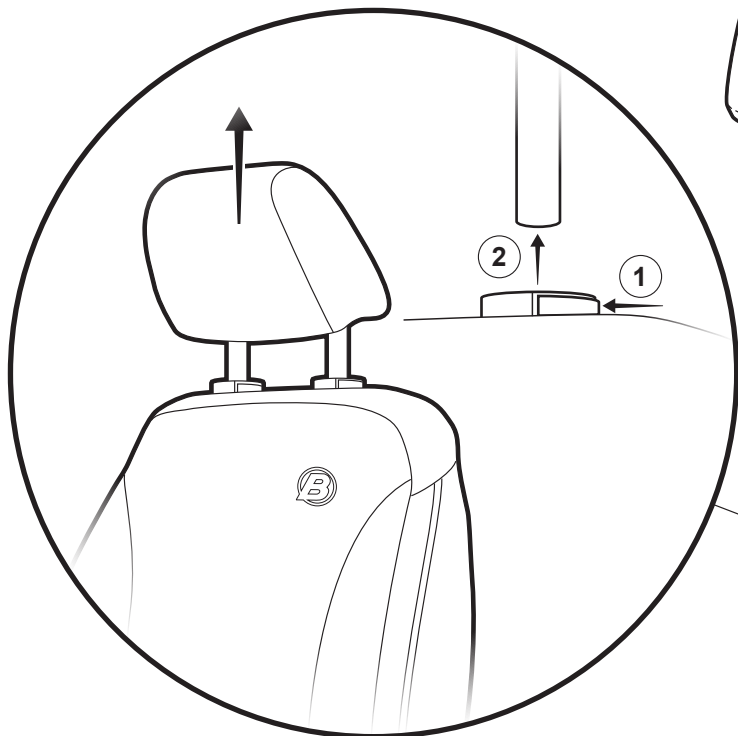

Use the headrest covers labeled to match your vehicle's headrest material.

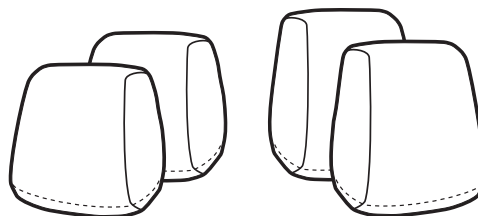

Step 2

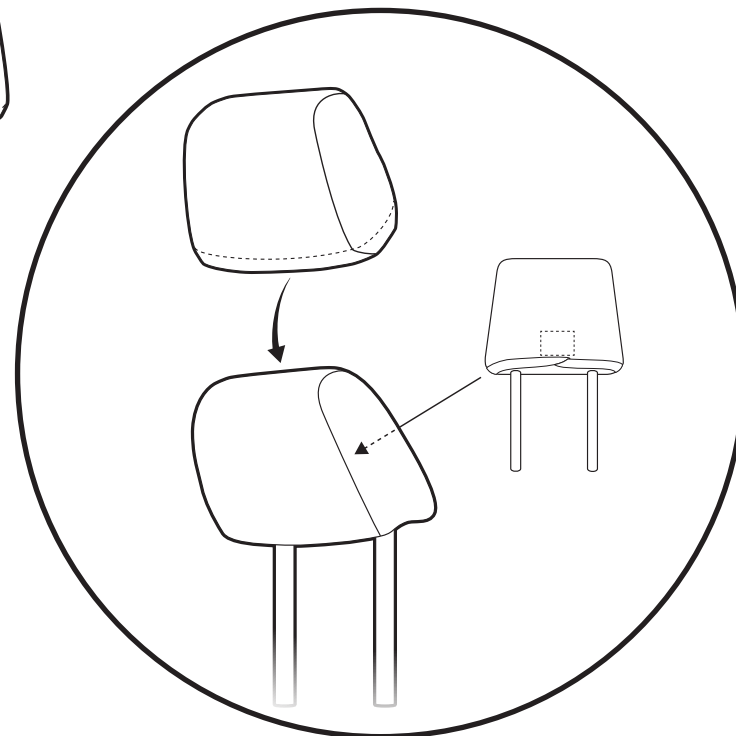

Step 1

Remove the headrest from the driver's seat by pushing in on the release buttons supporting the headrest shafts and lifting up on the headrest.

Repeat this procedure for the passenger side seat.



Step 2

Select the correct headrest covers from the 4 headrest covers that come in the installation kit. Use the headrest covers labeled to match your vehicle's headrest material.

Wrap the headrest covers over the headrests, making sure that the crossed elastic edging and internal label are at the back of each headrest. Adjust the seams for a smoother appearance.

Set headrests aside - do not reinstall at this time.

Step 1

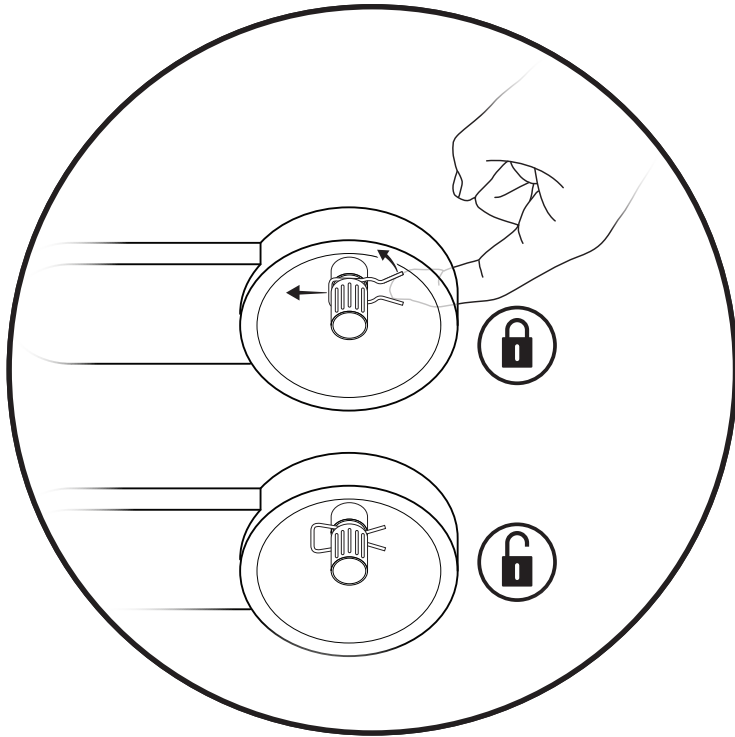

Note:
The retaining clip should remain attached to the seatback tilt lever.

Step 2

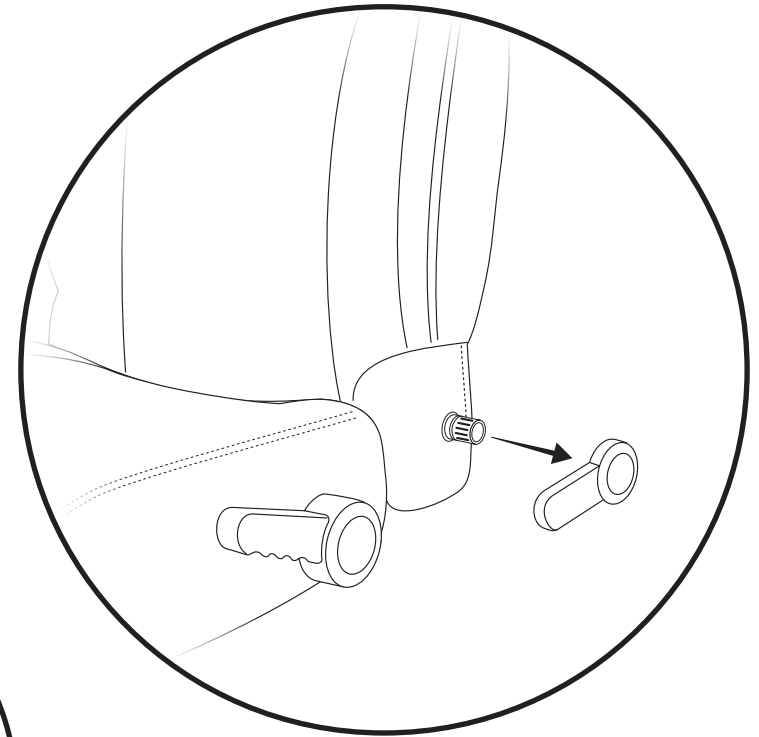

Step 1

Remove the driver side seatback tilt lever by using a finger to lift and pull the top spring clip wire up, and push toward the front of the seat to unlock the lever from the shaft.

Repeat this procedure on the passenger seat. Note that the spring clip open end faces the rear of the vehicle on both the driver and passenger sides of the vehicle.

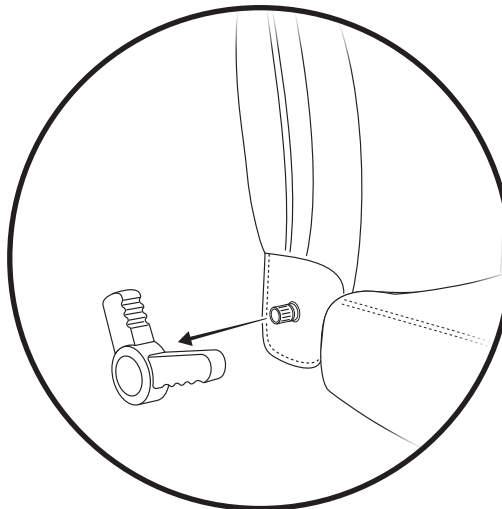

2-Door
Passenger side shown

Step 2

Once the spring clip is in the unlocked position, pull the lever straight off the shaft. After removing the lever from the shaft, push the spring clip back into the locked position, and set the lever aside for now.

Repeat this procedure on the passenger seat. Note that the passenger seat in 2-door vehicles has one 2-arm lever, which removes the same way as the single-arm levers in 4-door vehicles.

WARNING to preserve airbag functionality, you **MUST** remove the seatback tilt levers before placing the seat covers over the seats.

Step 1

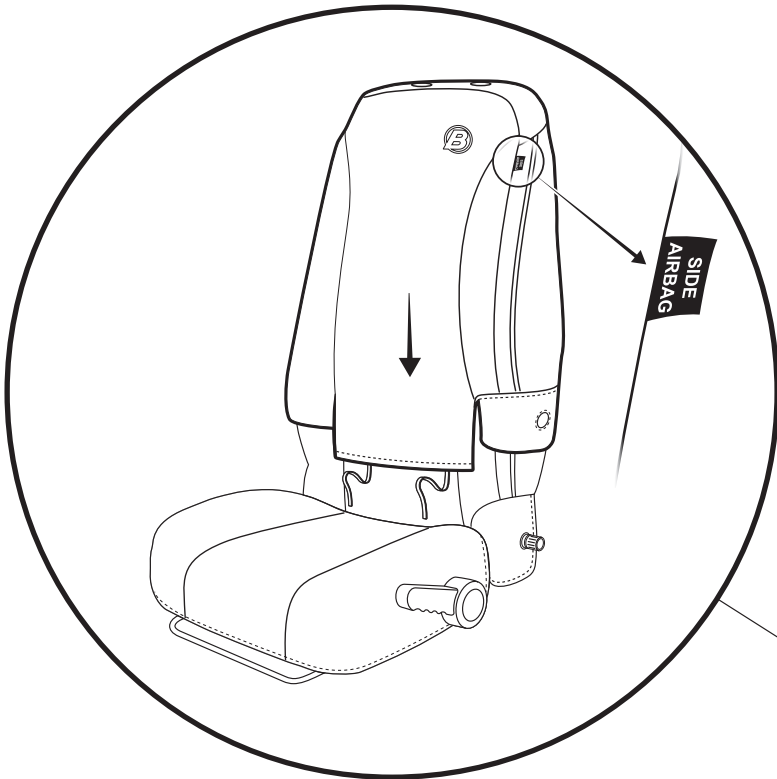

Step 1

Slip the driver-side seat cover over the driver's seat, gently working the fabric down over the seat. Make sure that the Side Airbag tag is nearest the vehicle door.

Repeat this procedure on the passenger seat.

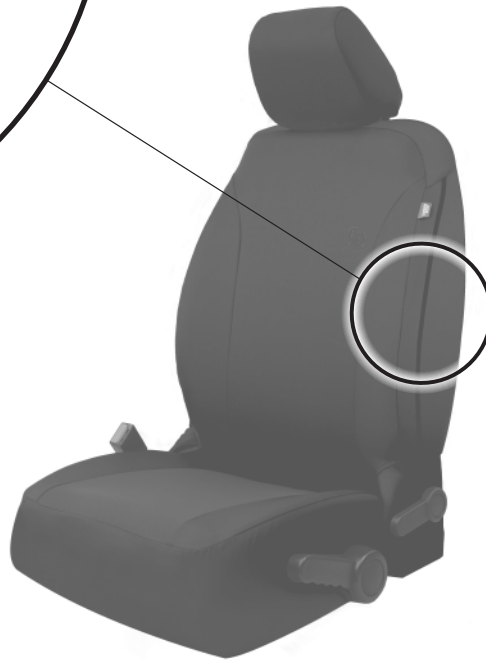

Step 2

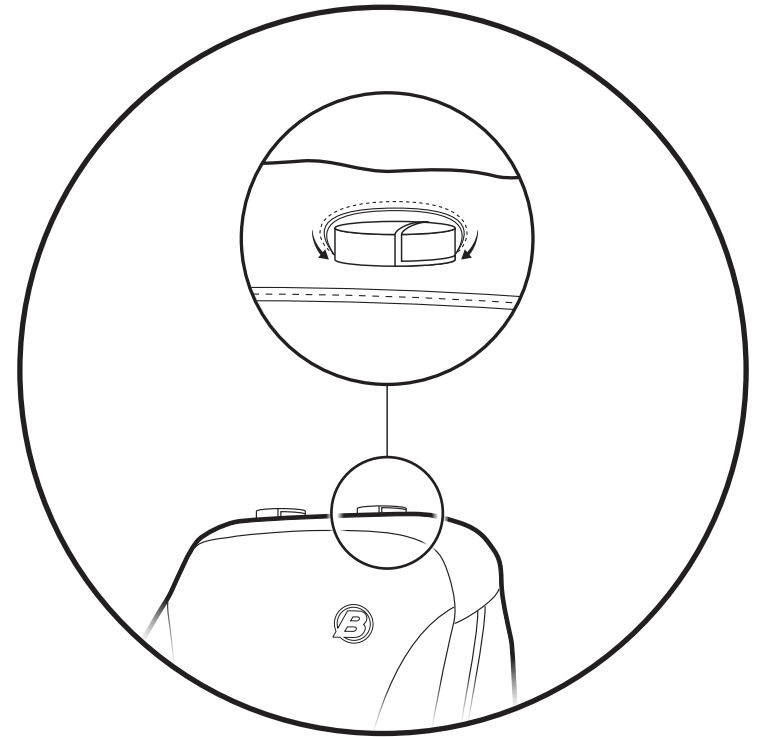

Step 2

Carefully stretch and tuck the seat cover fabric around and under the headrest release buttons on both driver and passenger seat covers.

Step 1

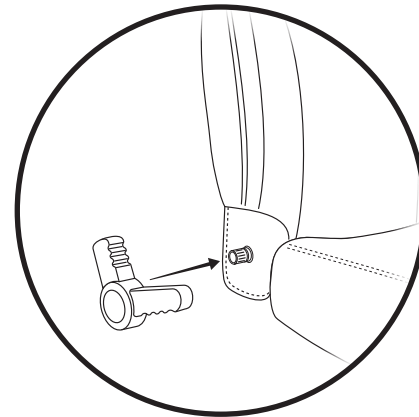
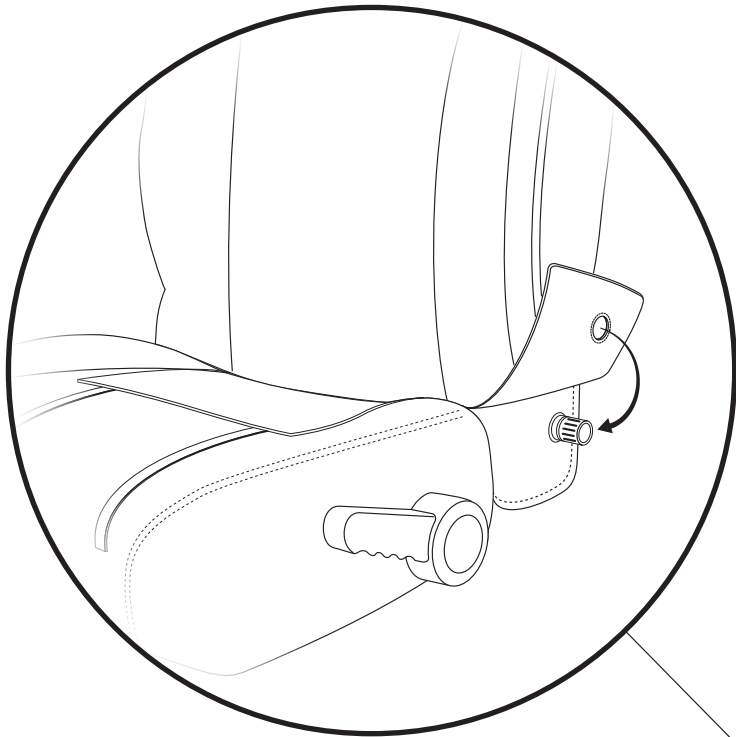

2-Door
Passenger side shown

Step 2

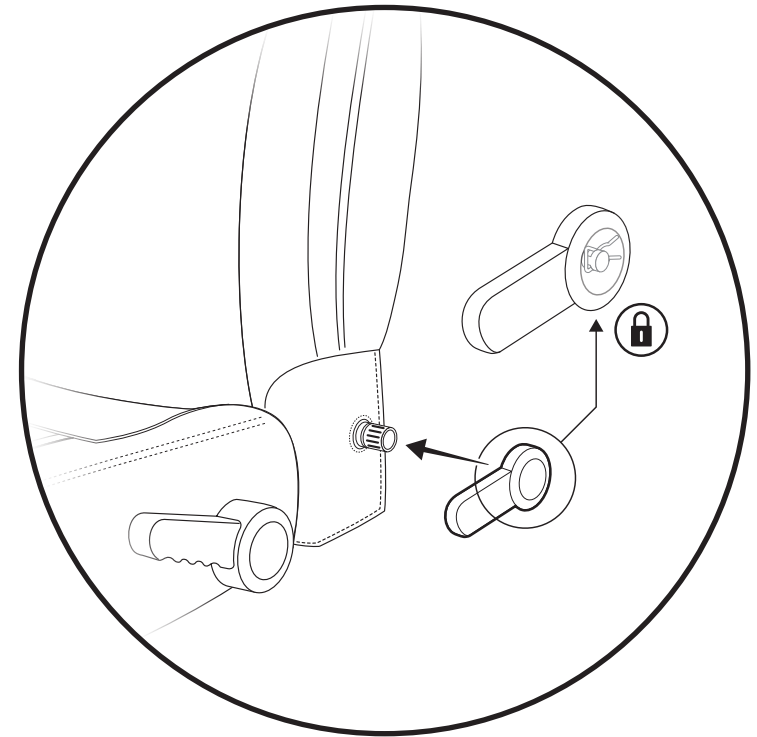

Step 1

Let the fabric flap drop into place, stretching the fabric to make sure the seatback tilt lever shaft protrudes through the hole in the flap.

Repeat this procedure for the passenger seat.

Note: Passenger side lever is different on 2-door vehicles.



Step 2

Push the fabric back to expose the groove on the shaft if necessary, and with the retaining clip in the locked position on the seatback tilt lever, slide the lever onto the shaft on the seat until the retaining clip snaps into place.

Give the lever a tug once the clip has snapped into place to make sure that the lever is secure on the shaft.

Repeat this procedure for the passenger seat.

Step 1

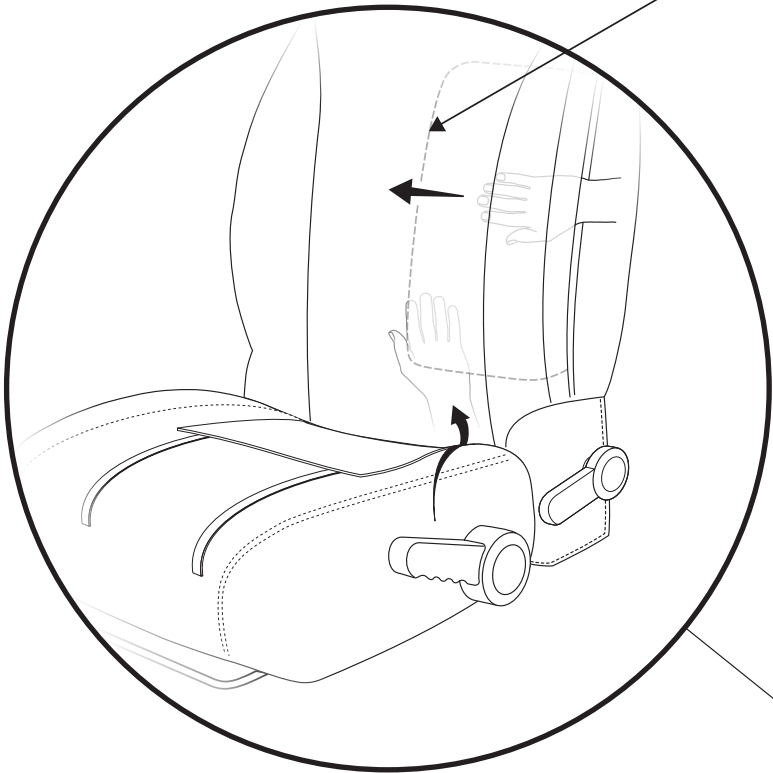

NOTE: the airbag flap should lie flat and smooth under the seat cover.

Step 2

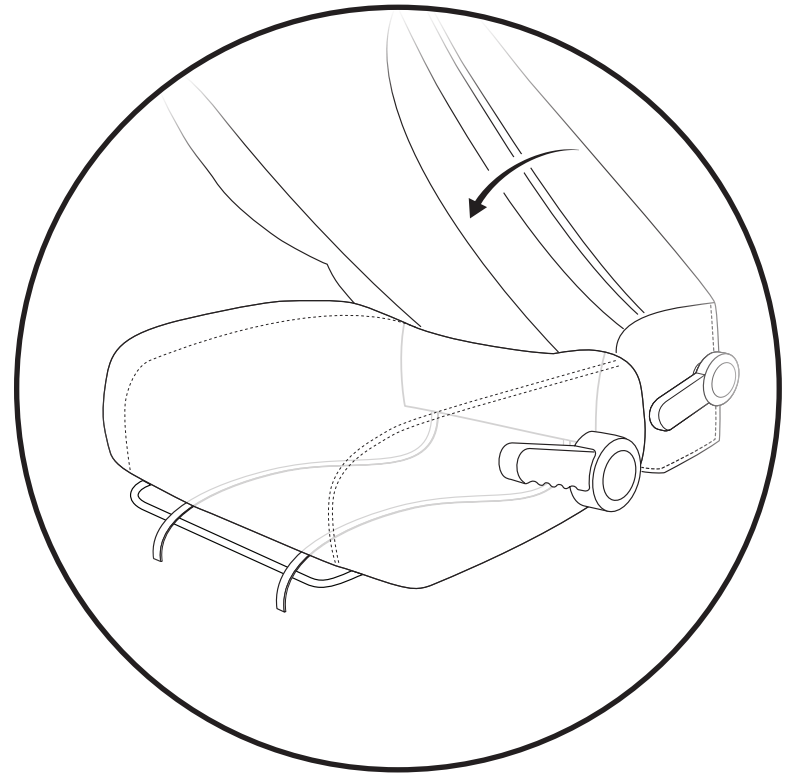

Step 1

Before you tuck the flap at the bottom of the cover between the seatback and bottom, tuck the airbag flap into the airbag opening with one hand, while at the same time reaching up under the front of the seat cover with the other hand to pull the airbag flap tight and smooth inside the seat cover.

Repeat this procedure for the passenger seat.



Step 2

Tilt the seatback forward and tuck the flap and the straps at the bottom of the seat cover between the seatback and the seat bottom, so the straps are underneath the seat.

Bring the straps forward, and drape them over the slide release bar at the front of the seat.

Repeat this procedure for the passenger seat.

Step 1

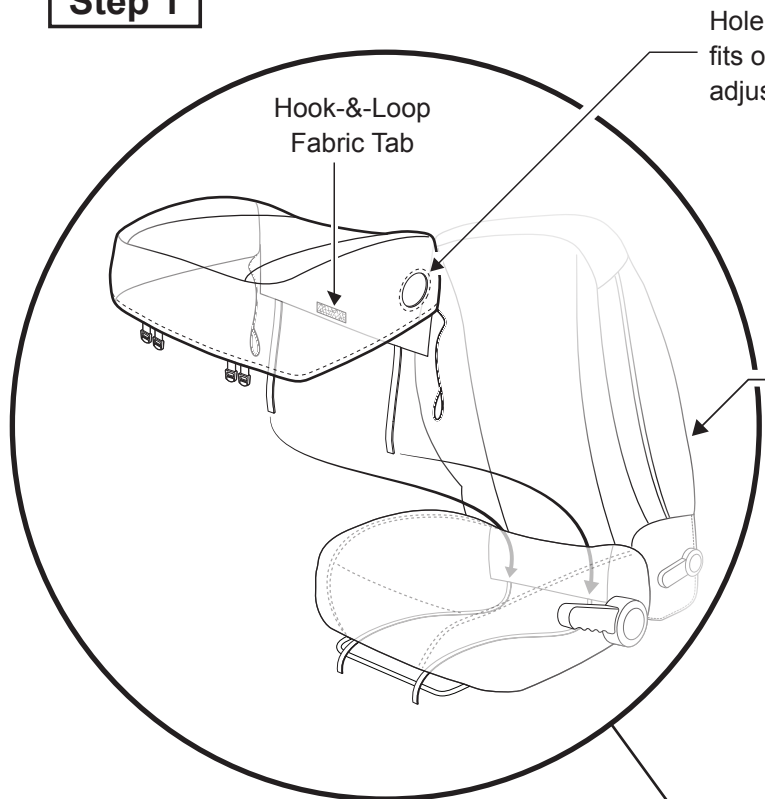

Hole in fabric fits over seat-height adjustment lever

Hook-&-Loop Fabric Tab

Note: Tilting the seatback forward slightly will allow easier access to tuck the straps and the flap between the seatback and seat bottom.

Step 2

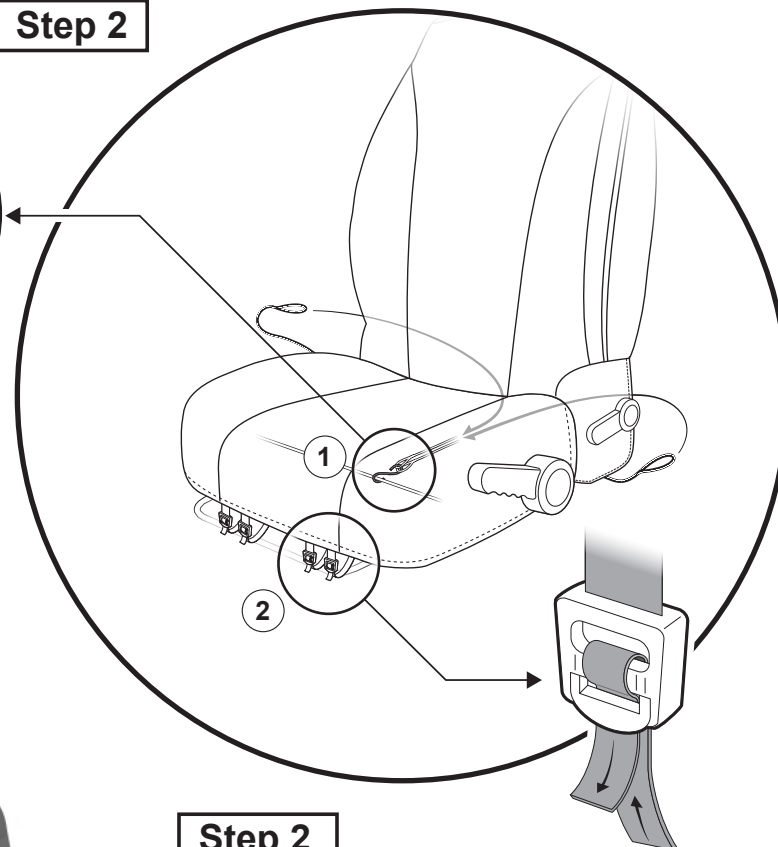

Step 2

Attach the two ends of the elastic cords to the closed end of the the s-hook. Attach the s-hook to a cross-member or wire underneath the seat, making sure to keep the cords away from the seat adjustment tracks.

Attach the 4 nylon straps at the front of the underside of the seat to the buckles. Give the straps a gentle tug to snug the covers.

Verify the straps do not interfere with or unplug any of the wiring found under the seat. Make sure that the seat will tilt forward and back, and slide from front to back without the seat rail snagging the straps.

Step 1

Slip the seat bottom cover over the seat, working the fabric toward the rear of the seat. Carefully fit the hole in the fabric over and around the seat height adjustment lever.

Tuck the nylon straps between the seatback and the seat bottom, and bring them to the front of the underside of the seat.

Tuck the flap between the seatback and seat bottom, and attach the hook-&-loop fabric tab on the inside of the seat cover flap to the carpeted area underneath the rear of the seat bottom.



Step 1

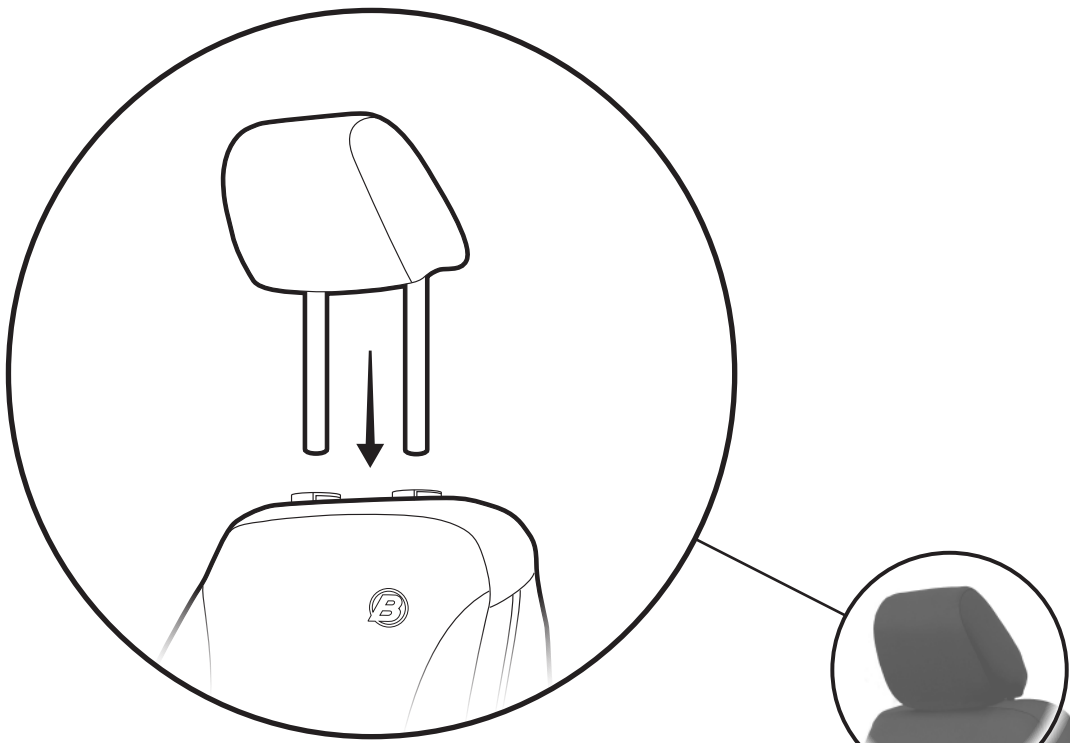

Step 1

Replace the headrests on both the driver and passenger seats.

