

**Diesel Snorkel Installation Instructions: 2007- Present JK Wrangler 2DR & 4DR Unlimited**

**Contents:**

- |                             |                                   |
|-----------------------------|-----------------------------------|
| (1) Main Body               | (4) M6 Short Caps Head Bolt       |
| (1) Rugged Ridge Logo Plate | (2) M6 Long Caps Head Bolt        |
| (1) Air Tube                | (6) M6 Flat Washer                |
| (1) Air Box                 | (1) Fender & intake □Gasket (24□) |
| (2) M8 x 35mm Hex Head Bolt | (1) Low Mount Air Intake          |
| (4) M8 Flat Washer          | (1) Cowl Re-mount Bracket         |
| (2) M8 Nut                  | (4) M6 x 20mm Flange Hex Bolt     |
| (1) 90deg Elbow             | (4) M6 Flange Nut                 |
| (1) Coupling                | (2) Plastic Spacer                |
| (4) Hose Clamp              | (1) Cowl □Bracket                 |
| (1) 3/8□Drain Hose (12□)    | (1) Cowl Nut Plate (M5)           |
| (1) 3/8□Drain Valve         | (4) M5 x 25mm Phillips Head Bolt  |
| (3) 3/8□Hose Clamp          | (4) M5 Nylon Cowl Washer          |
| (4) Air Box Sealing Clamp   |                                   |

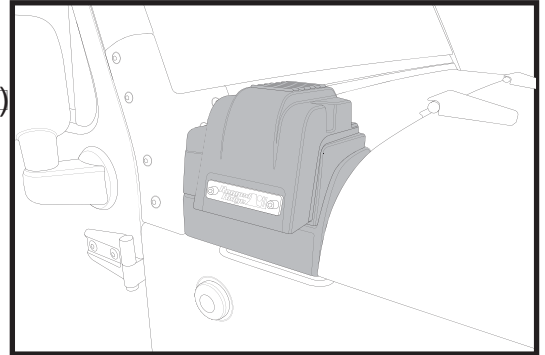

Patent # USD687071 , USD687072

**XHD snorkel system has been designed for 2007-Present JK Wangler 4dr Unlimited & 2dr LHD models equipped with 2.8L Turbo Diesel (I4). This kit cannot be used on petro (gas) powered Wranglers (3.8L, 3.6L). Snorkel system cannot be installed on RHD vehicles.**

**NOTICE:** Modular XHD Snorkel will require drilling, cutting and modification of vehicle. Before proceeding please read installation instructions for complete understanding of skills required for installation. To assure optimum performance and durability of your XHD snorkel system a professional installer may be required. System should be installed loosely to insure proper fit before final installation is performed.

XHD snorkel has been designed for use with either a stock or lifted suspension systems. Snorkel should not be used with body lifts over 1□ Body lifts taller than 1□will cause misalignment of intake components possibly resulting in failure of sealed system. Final inspection by installer should be performed to insure all intake connections are properly sealed and tightened before operation of vehicle.

**Special tools & Materials:** Following items are required for proper installation.

- |   |                                  |
|---|----------------------------------|
| (1) Drill / with 1/8□, 5/16□and 7/32□drill bits             | (6) 1" - 2" Putty knife          |
| (2) Angle grinder or Dremmel tool / with metal cutoff wheel | (7) Body color touch up paint    |
| (3) High quality sealant (RTV)                              | (8) Super glue                   |
| (4) (T-40) & (T-30) Torx bit screw driver or socket         | (9) Allen wrench set             |
| (5) Quality black satin spray paint & painters masking tape | (10) Sand paper or sanding block |

**1** - Remove RH windshield bracket. A T-40 socket will be required.



**2** - Remove windshield bracket and set to the side.

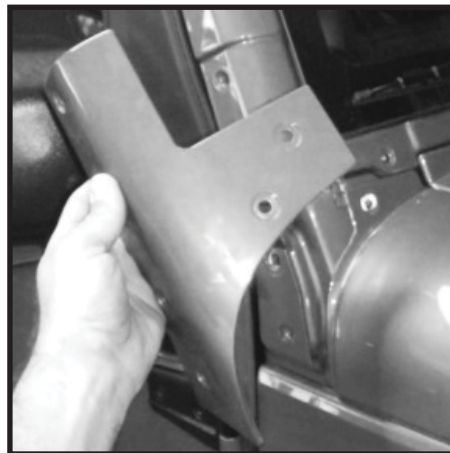

**3** - Remove the (4) cowl screws. A T-30 Screw driver or socket will be required.

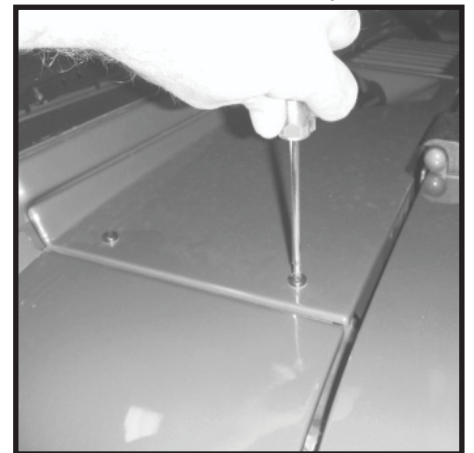

**Diesel snorkel Installation Instructions: 2007- Present JK Wrangler 2DR & 4DR Unlimited**

- 4** - Remove both wiper arms from vehicle.



- 5** - Using a flat head screw driver carefully remove cowl center plastic retainer clips.



- 6** - Carefully remove cowl cover from vehicle.



- 7** - Removal of front passenger side door is recommended. This will allow easy access to fender bolts. Follow owners manual for proper door removal steps. The help of a second person is recommended.



- 8** - Remove top four (10mm) fender bolts (arrows). Place bolts to the side noting location of each bolt. Bolts will be reused.

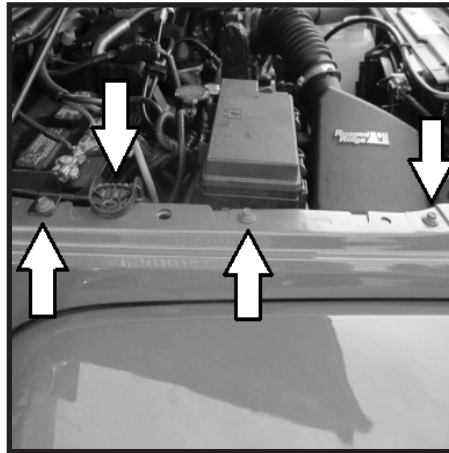

- 9** - Remove 2 inner cowl bolts located under cowl cover. note location of each bolt. Bolts will be reused.



**Diesel snorkel Installation Instructions: 2007- Present Wrangler 2DR & 4DR Unlimited**

- 10** - Remove 6 inner fender bolts (arrows). Note location of bolts. Bolts will be reused.

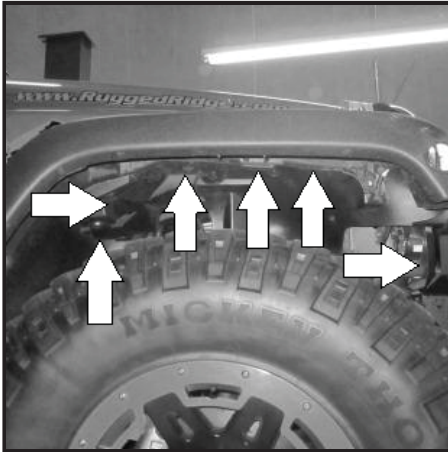

- 11** - Following four images show locations of key inner fender bolts. Rear inner bolt may be recessed under inner fender liner. See arrow for bolt location.

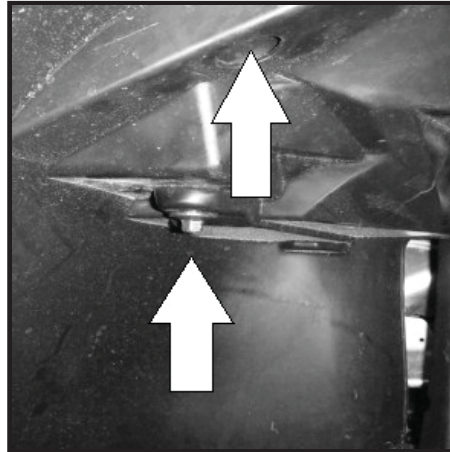

- 12** - Remove top fender support bolt.



- 13** - Remove front inner bolt. Bolt is located under inner liner just behind front grill.

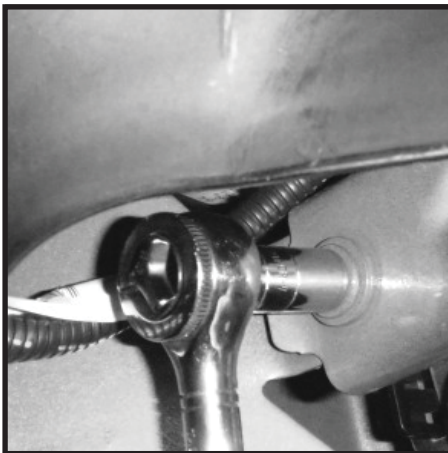

- 14** - Loosen inner door fender bolts. Do not remove. Allow enough clearance for fender to slide out easily. Notice: If door remains installed bolts should be removed to avoid damage to vehicle if door is closed.

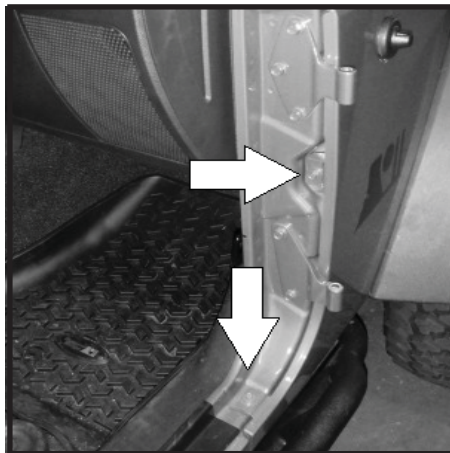

- 15** - Remove lower pinch weld fender bolts. Note location of bolts. Bolts will be reused. NOTICE: On some models rock rails or side steps will need to be removed before bolts can be accessed.

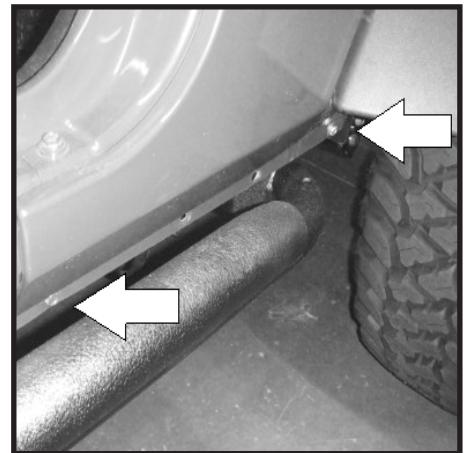

**Diesel snorkel Installation Instructions: 2007- Present JK Wrangler 2DR & 4DR Unlimited**

**16** - Before proceeding check to see that all fender bolts have been removed and loosened as described in steps 7-15. Total of 13 bolts should have been removed and 2 loosened. Lift battery tray up slightly and pushed up and away from fender (arrow).

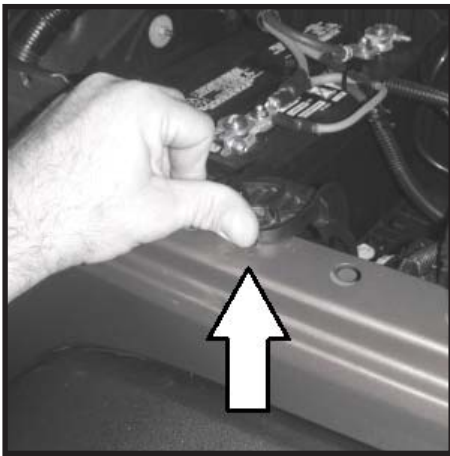

**17** - Top of rear fender will need to be lifted and cleared from inner mounting frame. If needed a small flat head screw driver can be used. Care must be taken to not bend the fender. Slide head of screw driver between the fender and frame. Carefully lift and pull fender too clear.



**18** - Top cowl section of fender may be adhered to body. A small flat head screw driver or putty knife can be used to release cowl section from body. painters tape can be used to protect windshield paint if leverage is needed to release top cowl section.



**19** - Reach under plastic fender and disconnect side marker light. Socket can be removed by turning socket counter clockwise and pulling away from fender.



**20** - Remove antenna mast from fender. With the assistance of another person pull fender away from vehicle just enough to disconnect antenna cable from fender.

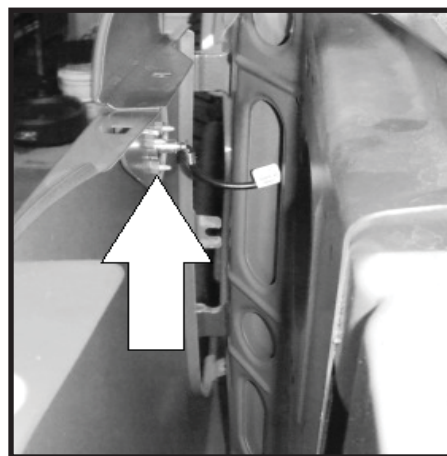

**21** - Carefully lift fender up and away from vehicle. Watch front grill and inner door bolts as fender is removed. Fender must be raised and slid over inner fender support bracket noted in step 12.



**Diesel snorkel Installation Instructions: 2007- Present JK Wrangler 2DR & 4DR Unlimited****WARNING! - Important Safety Information**

Protective eye ware and gloves should be used whenever power tools are in use. Failure to follow instructions may result in injury and or property damage.

- 22** - Fender should be supported to avoid damage. Locate the four spot welds securing removable upper cowl section to fender (arrows). Each spot weld will need to be removed.

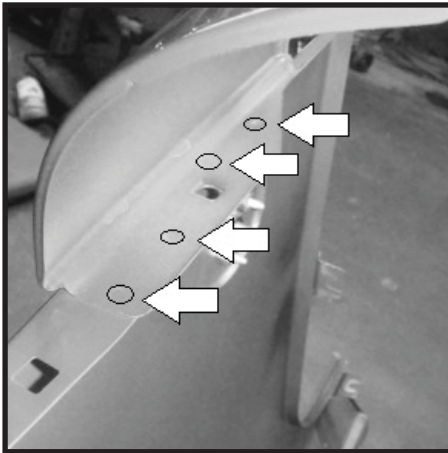

- 23** - Using a 1/8" drill bit drill center guide holes into each spot weld as shown. Place a wood block inside of cowl as guide holes are drilled. This will reduce the chance of damage to cowl sheet metal.

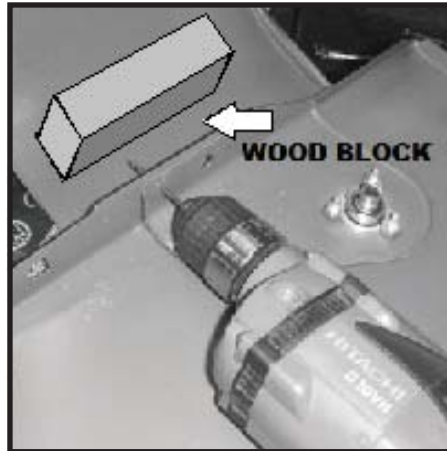

- 24** - Enlarge the (4) 1/8" guide holes with a 5/16" bit. Carefully open guide holes making sure to place wood block over holes. Drill bits can grab thin sheet metal and shoot forward damaging fender. Increase hole size if needed.

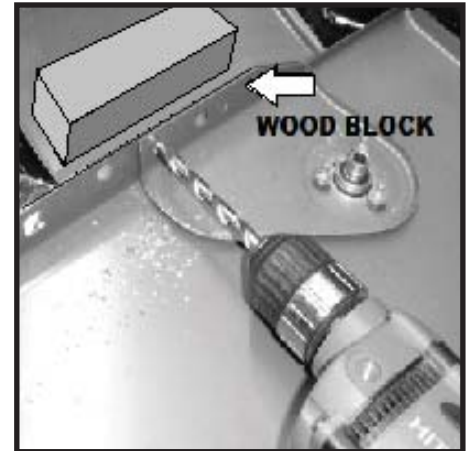

- 25** - With spot welds cleared carefully remove upper cowl from fender.  
NOTE: Fender can be damaged if welds have not been opened completely.



- 26** - Cut out template from page 19. Place template over fender as shown. Templates should be folded along dotted line and guide cut outs removed.

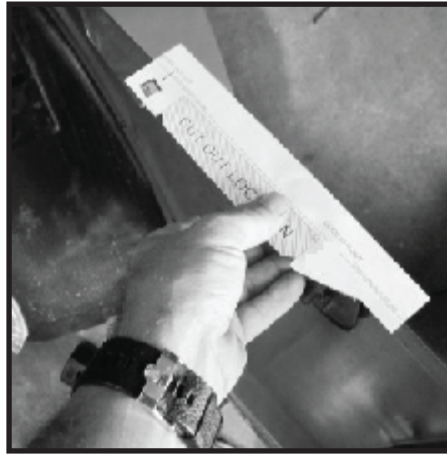

- 27** - Align fold and guide cut outs on fender. Secure with tape. Mark holes on fender as shown. If template does not fit correctly refer to page 19 for instructions.

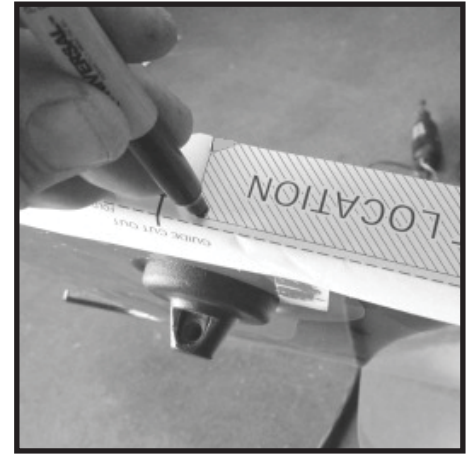

**Diesel snorkel Installation Instructions: 2007- present Wrangler 2DR & 4DR Unlimited**

**28** - Inner marks will be used to drill 7/32" cut line terminating holes. Notch marks will be used as cut starting points.  
NOTE: Cut lines near outer face of fender must be 1/8" away from rolled edge. This will insure a clean installation and sealing surface to snorkel body.



**29** - With guide holes marked and guide holes drawn drill 1/8" centering holes into fender. Use a 7/32" drill bit to enlarge 1/8" guide holes. NOTICE: A wood block should be placed under marked hole as described in steps 23&24. Wood block will protect the fender if drill bit grabs panel.

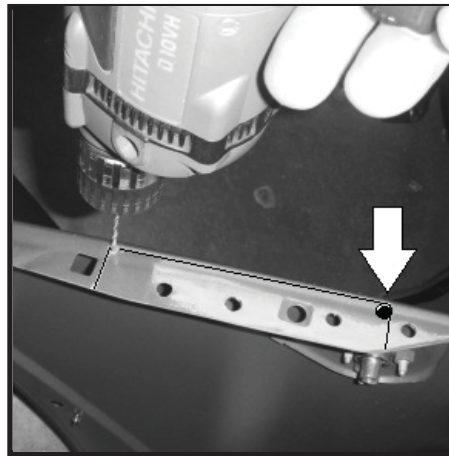

**30** - Using a Dremmel tool or angle grinder fitted with a metal cut-off wheel cut fender along marked lines. Cut should start in the middle of outer cut line (arrow). Cut should be 1/8" away from rolled edge. Cut in each direction towards 7/32" terminating holes (arrows).

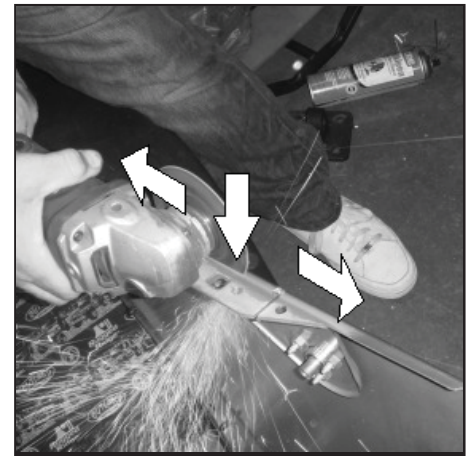

**31** - Allow steel to cool before touching. Remove cut section from fender. Care should be taken when handling rough cut steel.

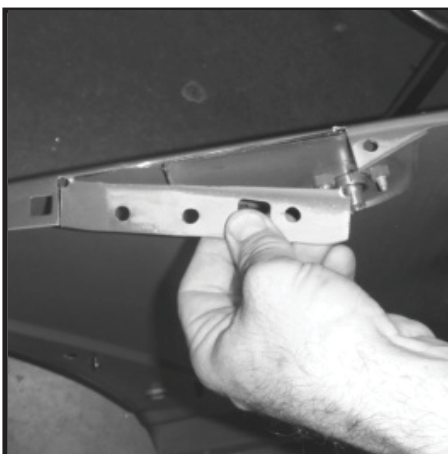

**32** - Carefully trim extra metal from inner antenna support bracket as shown. DO NOT cut too deep or damage to outer fender may result. A Dremmel tool with a cut-off wheel is recommended.



**33** - After cooling remove cut metal from fender. Care should be taken when handling rough cut metal. Removal of inner section will allow gasket to rest flush with fender.

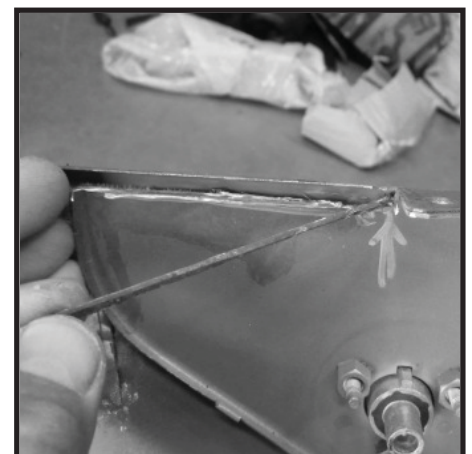

**Diesel snorkel Installation Instructions: 2007- Present JK Wrangler 2DR & 4DR Unlimited**

**34** - Test fit fender gasket as shown. Gasket should rest flat onto fender. If gasket does not fit flat around cut opening trim inner antenna bracket as needed.

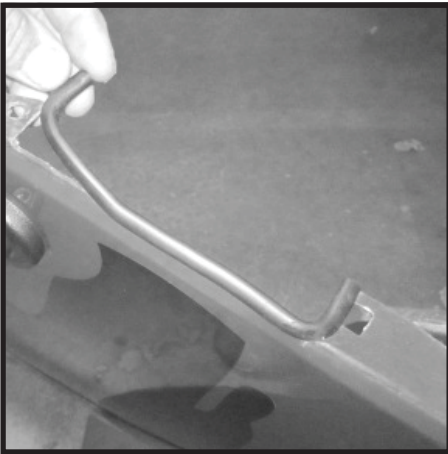

**35** - With gasket in place test fit main body of snorkel into cut section as shown. Trim fender as needed. Avoid getting too close to the outer edge of fender. Trimming too far will result in a visible gap (arrow).

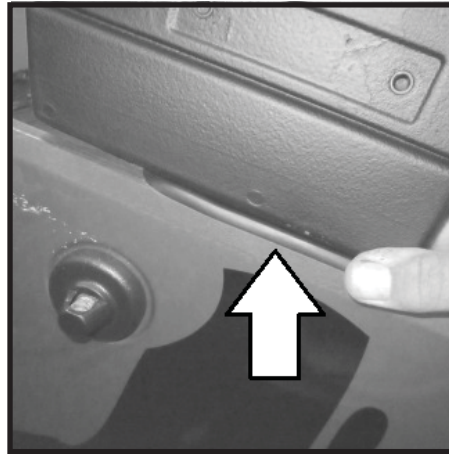

**36** - Use 100 grit sand paper or sanding block to smooth rough cut metal.

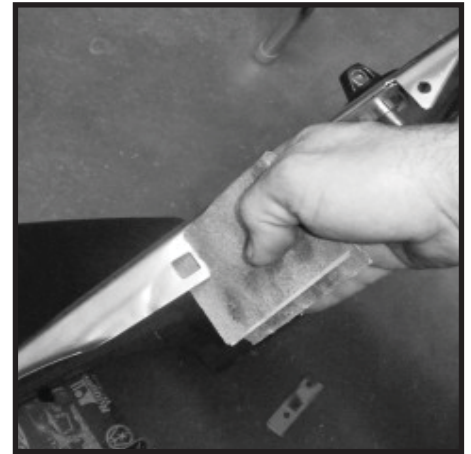

**37** - With opening trimmed to correct size and edges smoothed apply a protective coat of paint. Matching touch up paint is recommended. Clear coat can also be used.

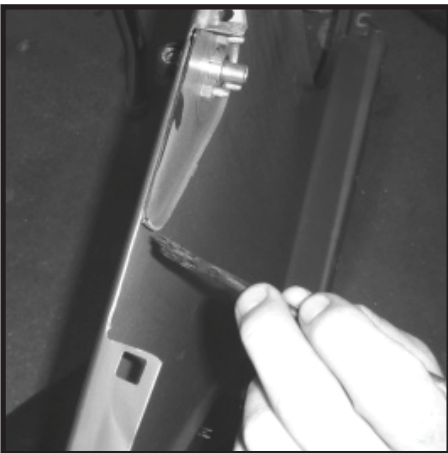

**38** - Apply a very small amount of super glue to inner corners of 1/2" Gasket. It will be easier to start at one end and work around opening applying glue as needed. This will insure 1/2" Gasket remains in place during reassembly.



**39** - Trim extra gasket as needed.

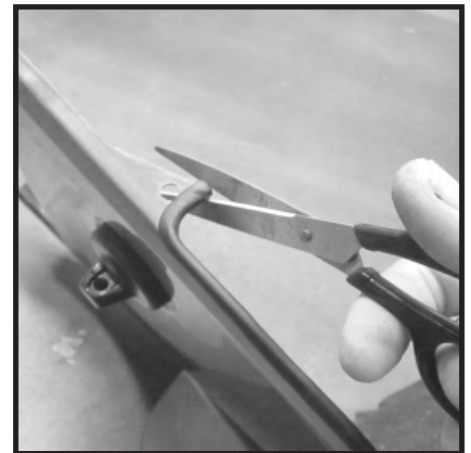

**Diesel snorkel Installation Instructions: 2007- Present JK Wrangler 2DR & 4DR Unlimited**

- 40** - Disconnect factory retainer clamps securing upper air box to lower air box intake. Using a flat head screw driver loosen 3" hose clamp from upper air box as shown. Sensor harness should not be disconnected. Lift upper air box off and set aside.

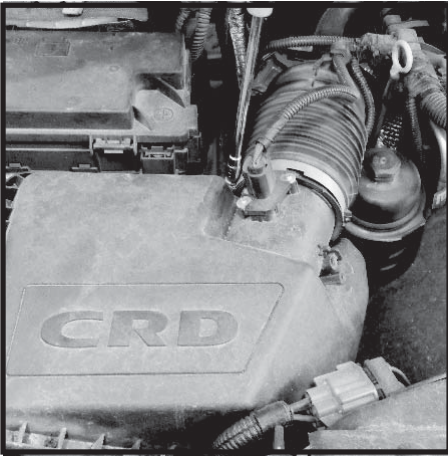

- 41** - Remove factory air filter and set to the side. Filter can be reused if clean. A high flow after-market air filter can also be used with XHD diesel snorkel system.

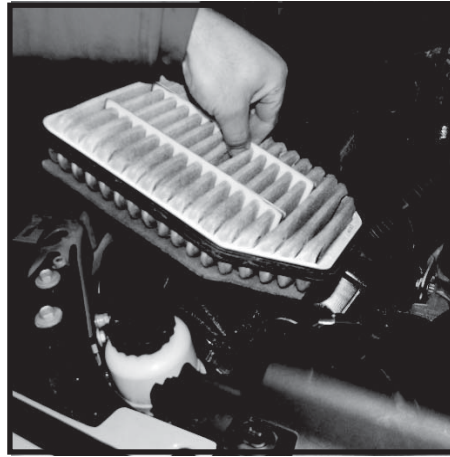

- 42** - Remove lower air box from vehicle. Air box is held in place with location pins. Simply pull upwards and out of rubber retainer grommets.

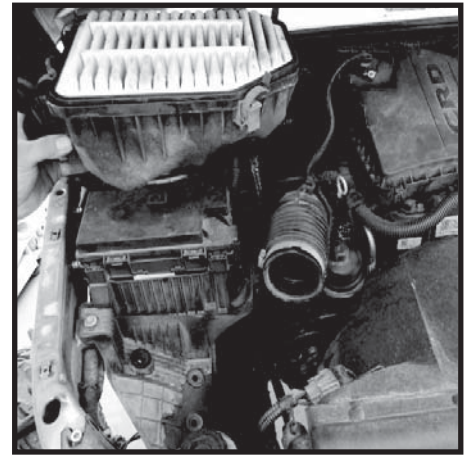

- 43** - Locate 10mm bolt securing brake line bracket to left hand side of frame. (Passenger side). Loosen bolt but do not remove.

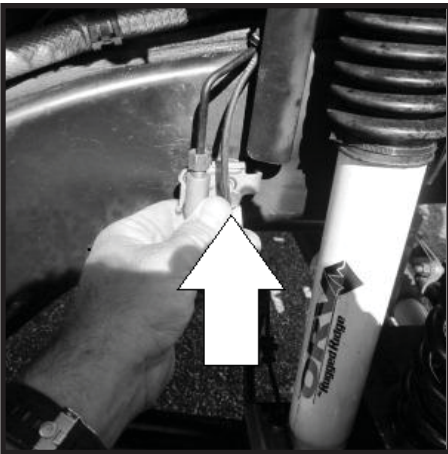

- 44** - Insert Air Tube from fire wall forward between shock tower and motor. Front of tube will fit just to the left of power steering pulley. Insert mounting tab behind brake bracket.

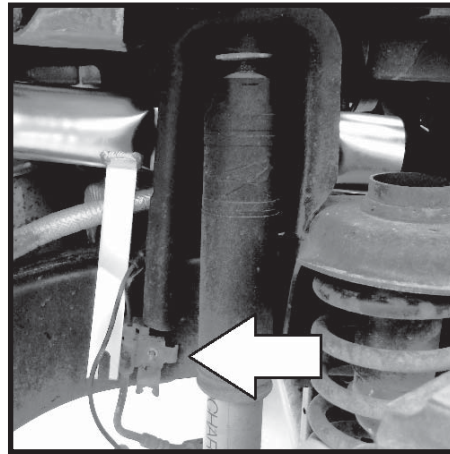

- 45** - Inspect front of Air Tube. Air Tube should rest between shock tower and power steering pulley. Confirm Air Tube does not make contact with any other component.

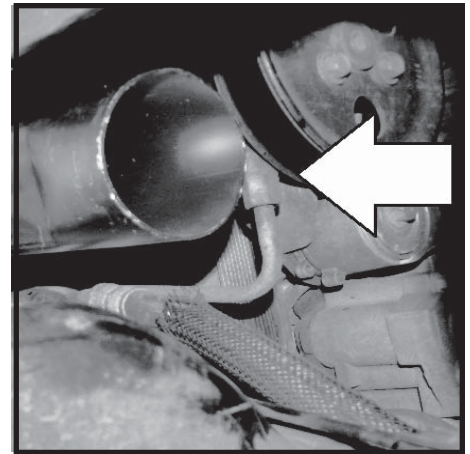



**Diesel snorkel Installation Instructions: 2007- Present JK Wrangler 2DR & 4DR Unlimited**

**46-** Place hose clamps onto both ends of the Air Tube. Lower Hose Clamp should have screw face at the bottom of the Air Tube facing outwards as shown. The upper Hose Clamp should have screw face at the top facing outwards.

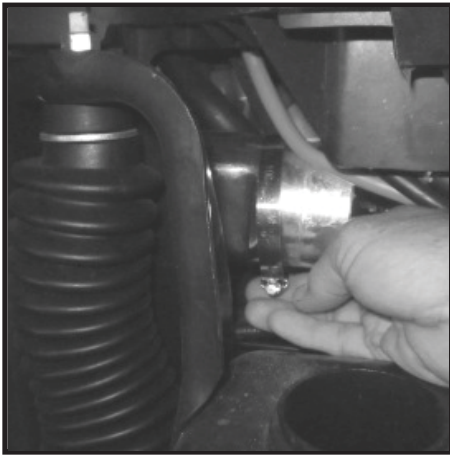

**47-** Place 90deg Elbow onto Air Tube. DO NOT install Hose Clamp. A test fit of Air Box will be required. 90deg Elbow will be removed and adjustments made prior to final assemble.

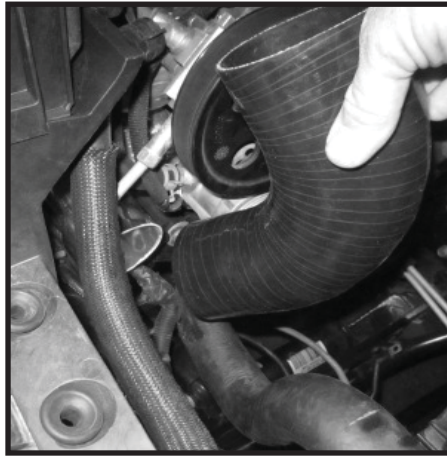

**48 -** Place new Air Box onto 90deg Elbow. Making sure elbow is fully seated to Air Box inlet. Air Box should rest within 1/8" (3mm) of rubber grommet.



**49-** If Air Box does not fit within 1/8" (3mm) of rubber grommets the top of the silicone 90deg Elbow will need to be trimmed. Remove Air Box and 90deg Elbow. If Air Box fits correctly proceed to step (51).



**50 -** Trim just enough of the 90deg Elbow for the Air Box to rest within 1/8" (3mm) of rubber grommets. Repeat step (48) making small adjustments to 90deg Elbow until fit is correct.



**51 -** With Air Box in the correct location, 90deg Elbow attached to lower Air Box inlet and aligned with the Air Tube. Carefully remove Air Box and 90deg Elbow together. Mark the position of the 90deg Elbow to Air Box as shown. remove elbow for step (52).

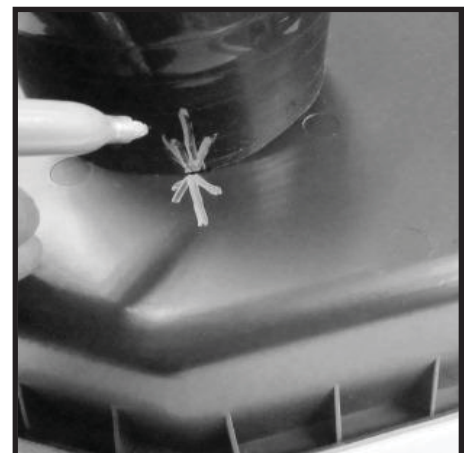

**Diesel snorkel Installation Instructions: 2007- Present JK Wrangler 2DR & 4DR Unlimited**

**52** - Apply a small amount of quality sealant to the inside of each end. Spread sealant evenly. A thin layer is all that will be needed for the inside to seal correctly. To much sealant can act like a lubricant during final assembly and cause tube to slide off inlet.

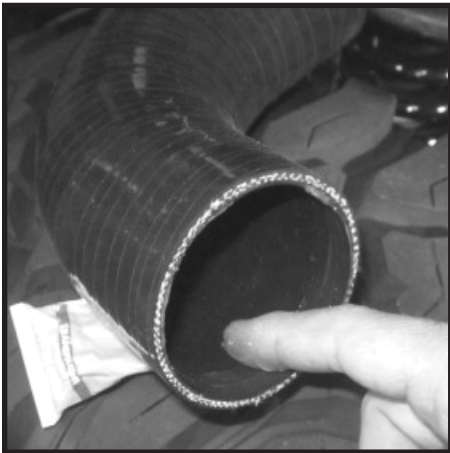

**53** - Reinstall 90deg Elbow to Air Box. Align marks made in step (51). Slide hose clamp onto elbow. With 90deg Elbow placed against bottom face of Air Box tighten Hose Clamp. Pull on 90deg Elbow to insure it is secured tightly to inlet.

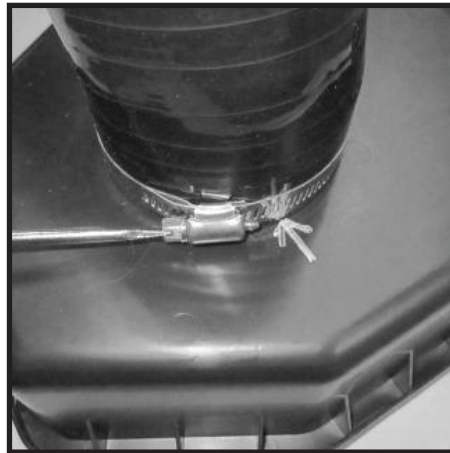

**54** - add extra sealant to the inside lip of lower Air Box inlet and 90deg Elbow as shown. Extra sealant can also be added to the outside as well.



**55** - Apply a thin film of sealant around end of Air Tube. An excessive amount may cause the elbow to slide off air tube when tightened.



**56** - Apply sealant to the inside of two lower rubber grommets as shown. Make sure sealant completely fills the two holes.



**57** - Apply extra sealant to top of grommets.



**Diesel snorkel Installation Instructions: 2007- Present JK Wrangler 2DR & 4DR Unlimited**

**58** - Apply sealant to corresponding holes on the underside of inner fender mounting plate.



**59** - Reinstall lower Air Box and 90deg Elbow. Slide 90deg Elbow over Air Tube. Apply extra sealant around outer edge of the 90deg Elbow and Air Tube. Slide Hose Clamp over 90deg Elbow but do not tighten at this time.

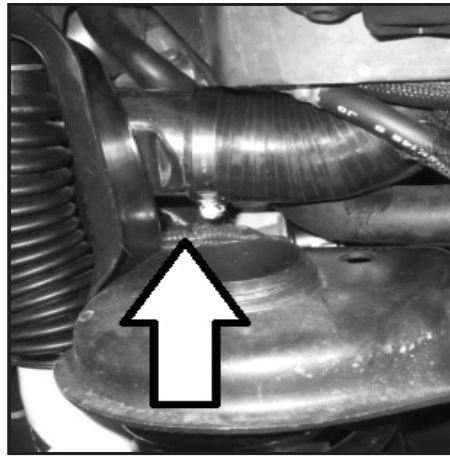

**60** - Insert (2) M8 x 35mm Bolts with (2) M8 Flat Washers through Air Box mounting holes and rubber grommets. Apply a small amount of sealant to washers.

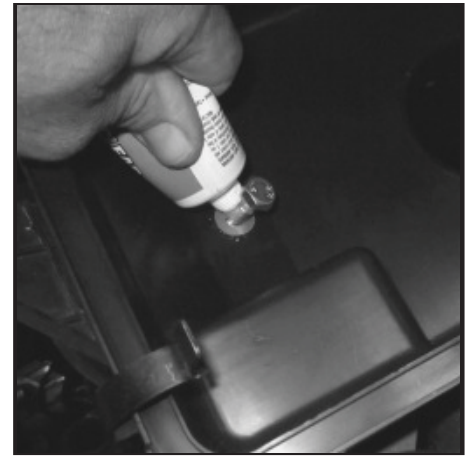

**61** - Install (2) M8 Nuts and (2) M8 Flat Washers to the underside of inner fender mounting plate. Add sealant if needed to insure a water tight seal.

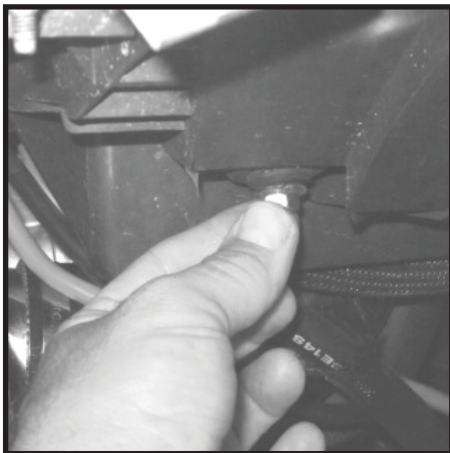

**62** - Tighten M8 hardware to secure new Air Box to vehicle. Inspect sealant around bolt heads and washers to insure there are no gaps. Smooth out sealant and clean off extra material.

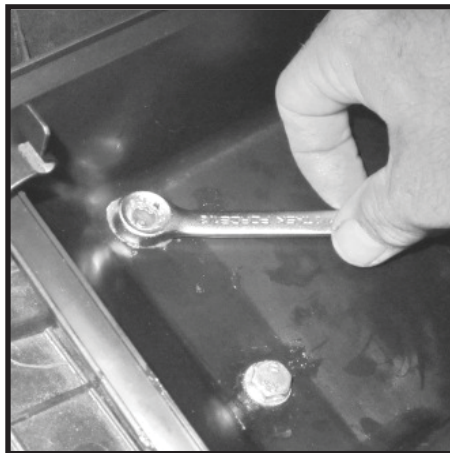

**63** - Inspect 90deg Elbow around lower radiator hose. 90 deg Elbow can have minor contact with radiator hose but should not be crushed or deformed to the point of restricting airflow.

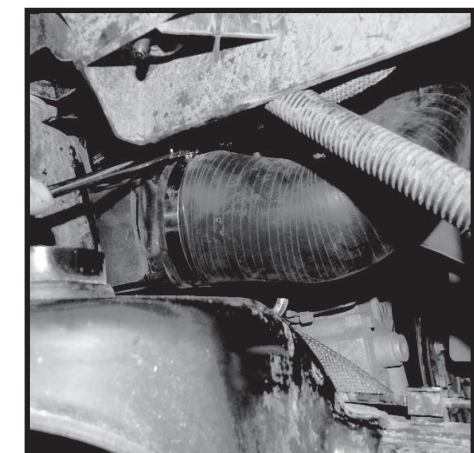

**Diesel snorkel Installation Instructions: 2007- Present JK Wrangler 2DR & 4DR Unlimited**

**64** - Painting the area behind the removed windshield plate is recommended (black). Quality painters tape and paint should be used. Liberally apply tape



**65** - Make sure painting is done in a well ventilated area. Paint should not be applied in a windy environment. This will insure overs-pray does not fall onto vehicle.

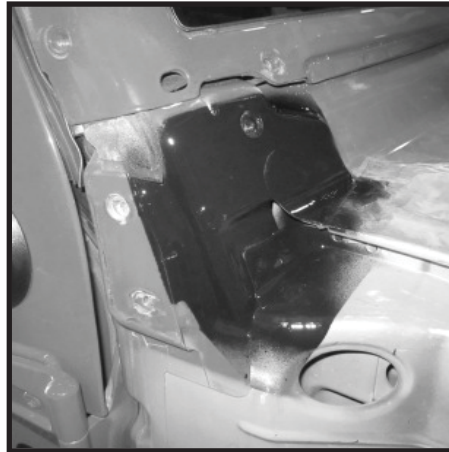

**66** - Install windshield bracket removed in step (2). Start and tighten upper side M12 bolts and front M12 bolts as shown. Windshield brackets can be adjusted. If needed a screw driver can be used to loosen windshields floating nut plates. This will allow for realignment of plate.



**67** - If used, windshield light mounting brackets should be installed at this time. NOTE: the snorkel system has been designed to work with most Rugged Ridge components. Rugged Ridge cannot guarantee that other manufactures components will work or clear the XHD snorkel system.

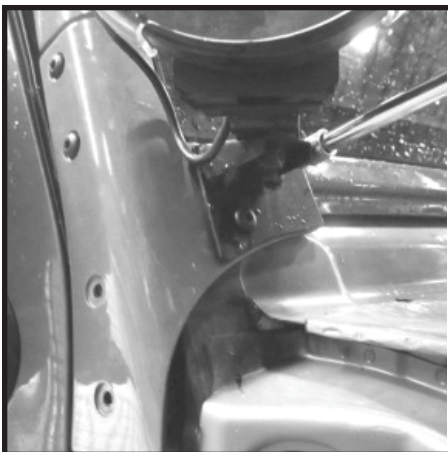

**68** - Install Cowl 1/2" Bracket plate reusing factory 10mm bolts removed in step (9). Secure the bolts but do not tighten at this time. Adjustment to main body will be required during install.

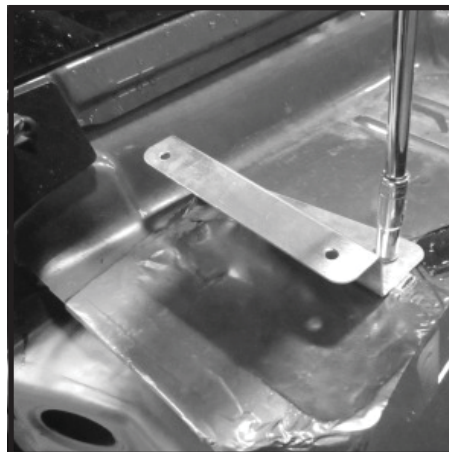

**69** - Dry fit Main Body, 90deg Elbow and Air Tube before applying sealant. If all parts line up apply a thin bead of sealant around the lower section of the snorkel Main Body. Spread sealant evenly around the outside of the main body outlet. A thin layer will insure an tight seal.



**Diesel snorkel Installation Instructions: 2007- Present JK Wrangler 2DR & 4DR Unlimited**

**70** - Add a small bead of sealant to the inside of Coupling and slide onto Air Tube. Secure Hose Clamp around Coupling, Do Not tighten. Smooth and clean extra sealant from around Coupling and Air Tube.



**71** - With sealant applied to main body outlet slip Hose Clamp onto Main Body outlet. Position snorkel Main Body onto vehicle sliding outlet into Coupling as shown. Slide Hose Clamp over Coupling but Do Not tighten.

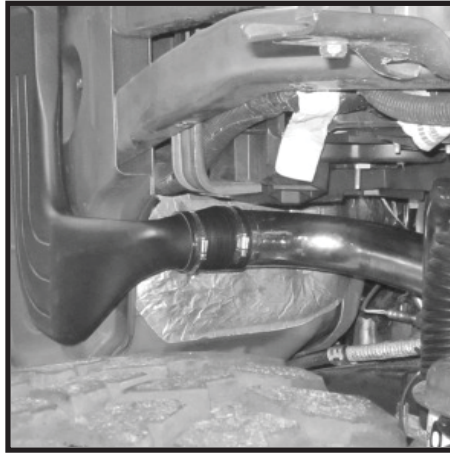

**72** - Snorkel Main Body should rest in place as shown. Snorkel Main Body should be fitted tight to inner frame. Some vehicles may require the pinch seam (arrow) to be rolled for proper fit. Check antenna cable position.



**73** - Inspect Cowl Bracket to Main Body alignment. Adjust Main Body and Cowl Bracket to align mounting holes. If needed Cowl Bracket can be adjusted (bent) to align all holes.

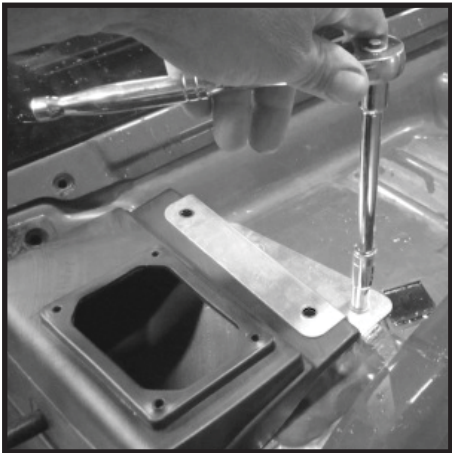

**74** - Place windshield cowl cover back onto vehicle. Align driver side top holes and insert (2) M6 x20 Phillips head screws and washers. Secure but do not tighten.

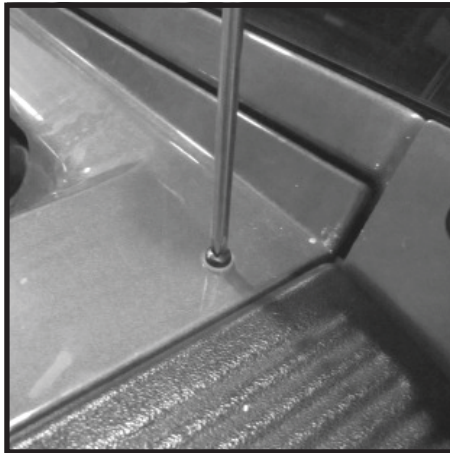

**75** - Check alignment of cowl cover and Main Body. Insert M6 x 20 Phillips head screws to align cover, Main Body and Cowl Bracket.

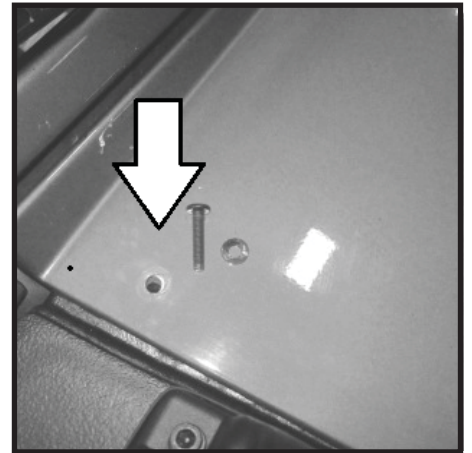

**Diesel snorkel Installation Instructions: 2007- Present JK Wrangler 2DR & 4DR Unlimited**

**76** - With cowl cover removed tighten Cowl Nut Plate - Bracket . Reinstall cowl cover and reinstall drivers side M6 x 20 screws and washers. Reattach center retainer clips removed in step (5).

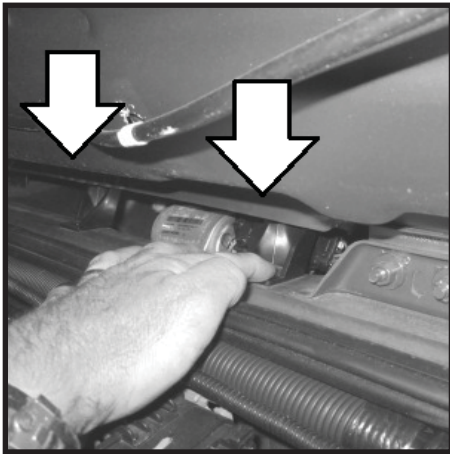

**77** - Locate Cowl Nut Plate. Nut plate is used to secure cowl cover and snorkel body to Cowl Nut Plate - Bracket.

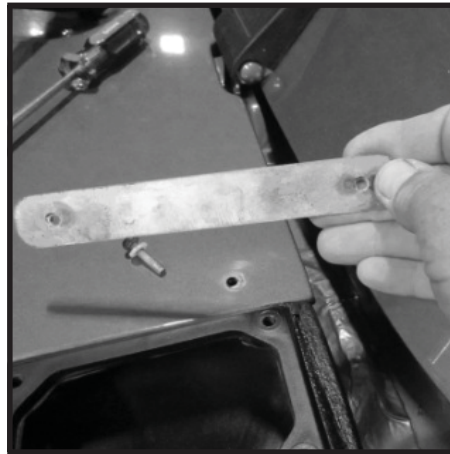

**78** - Slide Cowl Nut Plate under Main Body as shown. Working from engine compartment align mounting holes. Start one M6 Phillips head screw to hold in place.

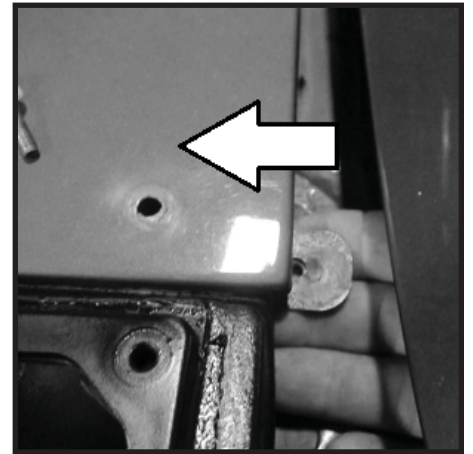

**79** - Secure all (4) M6 cowl mounting screws. Make sure M6 black washers are placed under M6 screws before tightening.



**80** - Reinstall wiper arms removed in step (4).

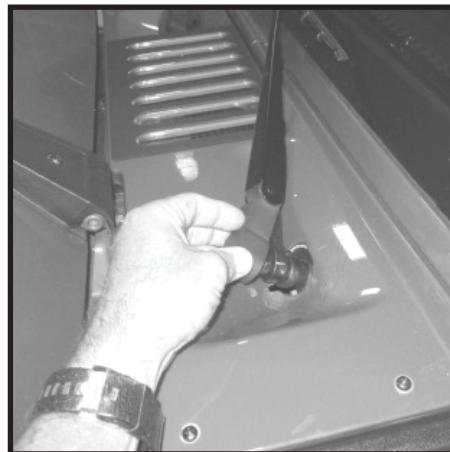

**81** - With Main Body installed inspect Air Tube. Tighten 10mm bolt at Air Tube mount and brake bracket.



**Diesel snorkel Installation Instructions: 2007- Present JK Wrangler 2DR & 4DR Unlimited**

**82** - Tighten all Hose Clamps.  
Wipe away sealant from air tube, coupling, and Main Body.

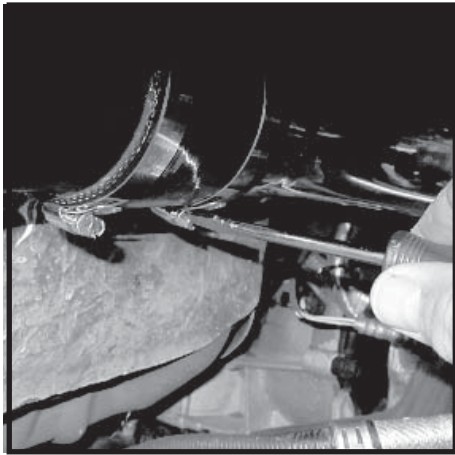

**83** - Slide 3/8" Drain Hose and 3/8" Hose Clamp to bottom of Main Body.



**84** - Drain Hose should be cut into two lengths. Top section should be about 8" long. The lower section will be 4" and trimmed as needed. Connect 3/8" Hose Clamps to 3/8" Drain Valve and tighten all clamps.

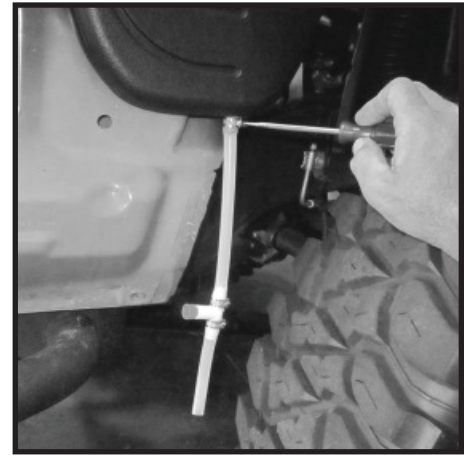

**85** - Reinstall air filter removed in step (41). A high flow filter can also be used if desired.



**86** - Reinstall factory upper air box removed in step (42). Rotate 3" intake hose back onto upper air box and secure factory hose clamp.

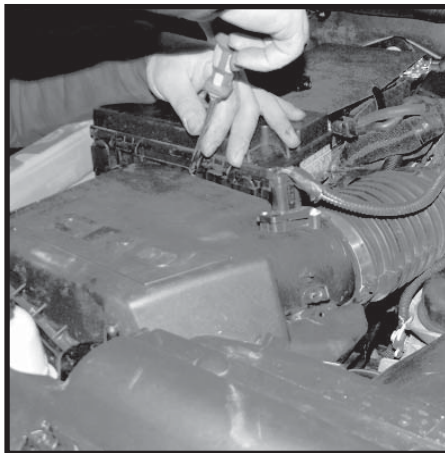

**87** - Adjust (4) air box sealing clamps full open. Clamps are designed to slip under lower air box flange and over flange and ribs of upper OE air box. Place clamps as shown (arrows). Secure but do not tighten clamps.

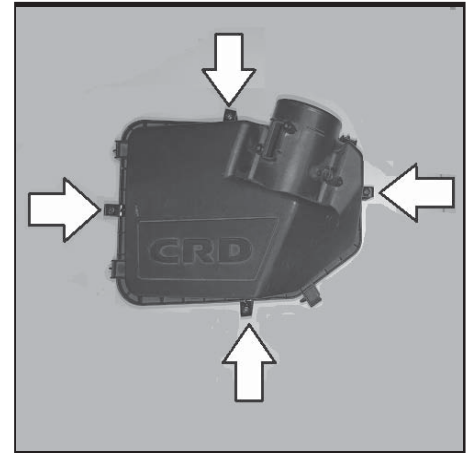

**Diesel snorkel Installation Instructions: 2007- Present JK Wrangler 2DR & 4DR Unlimited**

**89** - With all 13 bolts secured double check alignment of fender. Tighten all bolts.

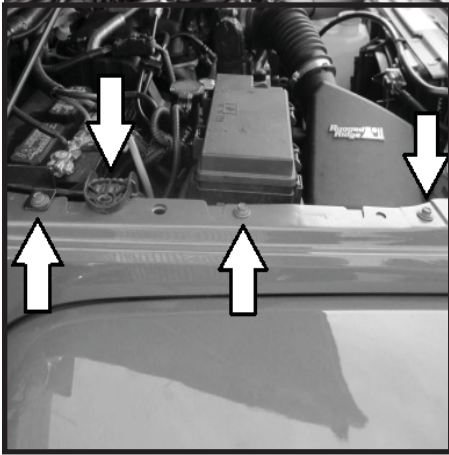

**89** - Reattach side marker bulb to inside of fender. To secure bulb turn socket clockwise.

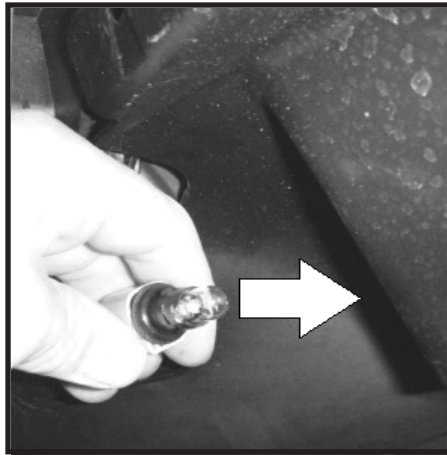

**90** - If door was removed reinstall and secure with factory door torx nuts. Side steps or rock rails should be reinstalled at this time. The help of a second person is recommended.



**91** - Tuck Drain Hose up behind inner fender liner and between lower fender and inner pinch weld. as shown.



**92** - Add 1/4" Gasket to low mount intake if not already installed to snorkel main body. Starting from lower intake edge work around the intake making sure gasket is fitted tight to intake. Trim gasket if needed.



**93** - Rest Low Mount Air intake onto Main Body as shown. lower (long) M6 caps head bolts will be started first. Starting front lower bolts first allows the intake to be popped into place over the Main Body intake.

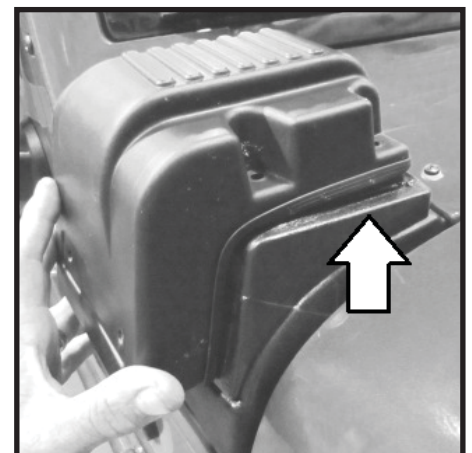



**Diesel snorkel Installation Instructions: 2007- present Wrangler 2DR & 4DR Unlimited**

**88** - Insert Plastic Spacers between Main Body and Low Mount Air Intake. Insert M6 x 55mm Caps Head Bolts through Logo Plate. Start threads but do not tighten.

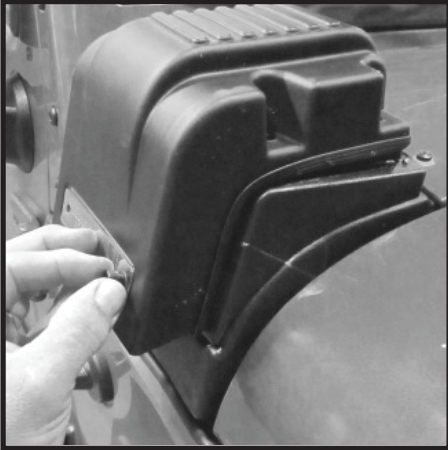

**89** - Press top of Low Mount Air Intake down onto Main Body. Intake will fit over top front of main body intake and pop over the rear of intake as shown.

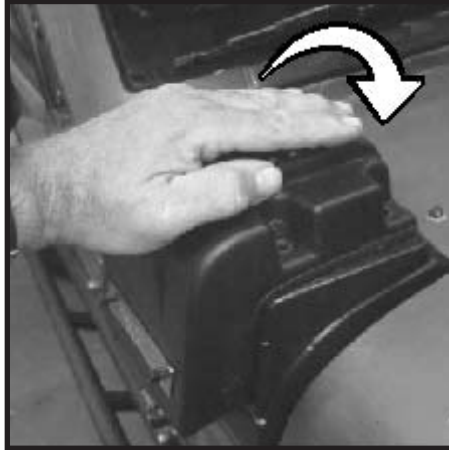

**90** - Using (4) M6 Short Caps Head Bolts and (4) M6 Flat Washers secure intake to Main Body.

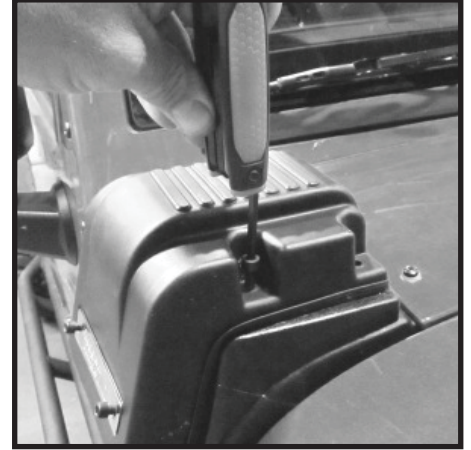

**91** - With Low Mount Air Intake secure pull outer edge of 1/2" gasket away from Low Mount Air Intake until 1/2" Gasket rest flat against side of intake.



**92** - Tighten all (6) caps head bolts. Do Not Over Tighten. A firm seal is all that is required.

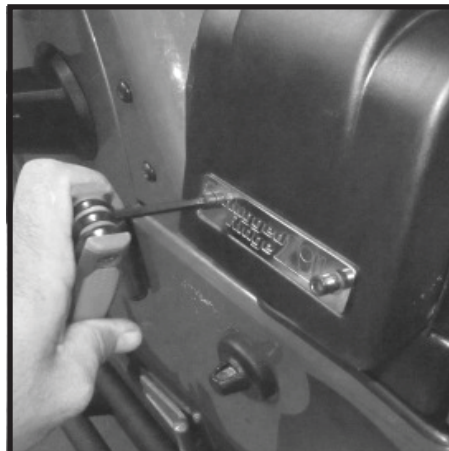

**93** - Reinstall antenna mast.



**Diesel snorkel Installation Instructions: 2007- present JK Wrangler 2DR & 4DR Unlimited**

Cowl Remount Plate: Remounting bracket is designed to return vehicle to stock configuration

- 1** - Snorkel kit includes a Cowl Re-mount Bracket. The bracket will allow snorkel to be removed and factory upper fender cowl bolted back into stock location.



- 2** - Fender and snorkel will need to be removed from vehicle. Refer to steps (1) through (21) of snorkel installation instructions for fender removal.



- 3** - Align Cowl Re-mount Bracket to the holes of upper fender cowl plate and fender. Plate will be placed under fender as shown.

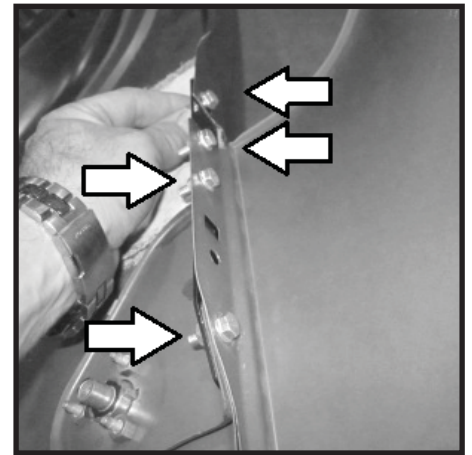

- 4** - Cowl should be aligned with outer edge of fender. Fender can be placed onto body to double check cowl placement (front to back). The left side fender can be used as a guide if needed.



- 5** - Tighten M6 x 20mm Flange Hex Head Bolt and M6 Flange Nuts before reinstalling fender on vehicle. When fender is being installed remember to connect antenna cable.

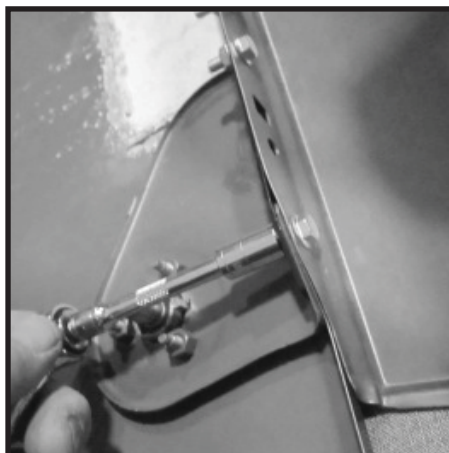

- 6** - Installation of fender is the reversal of steps (1)-(21) of the snorkel instructions. Reinstall windshield bracket. If windshield bracket does not line up correctly. Floating nut Plates in a-pillar can be broken free with a screwdriver to allow for additional movement.



**P/N: 17756.04, 17756.06, 17756.08**  
**Fender Template (1:1 scale)**

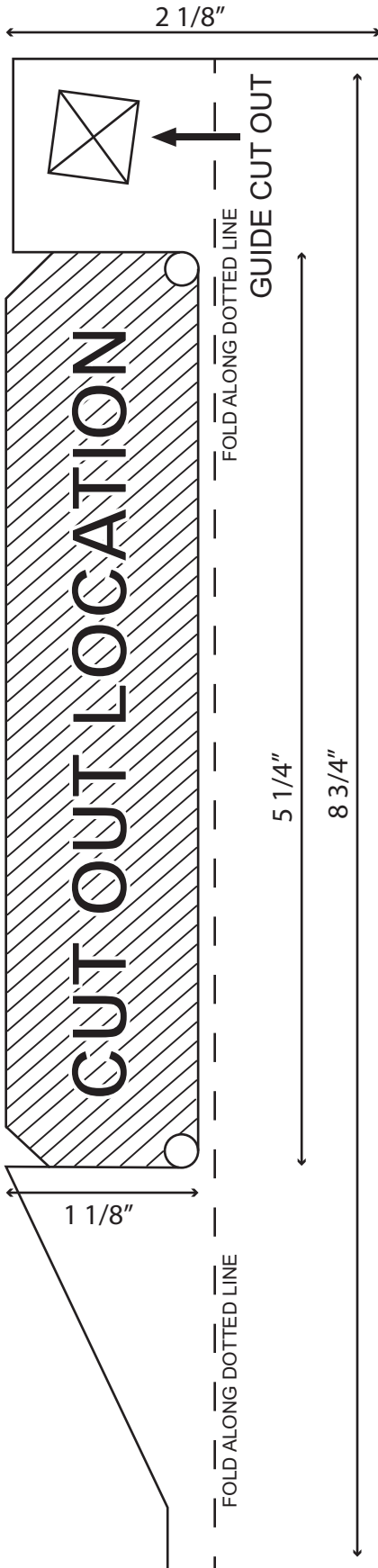

Cut out template using scissors or X-ATCO blade. The template is a (1:1) scale guide for cutting top of passenger side (LH) fender.

NOTICE: Make sure guide cut outs align correctly with the top of fender. If guide cut outs DO NOT MATCH top of fender please contact Rugged Ridge for correct template. Template ratio can change size during the printing process. Every effort is made to insure correct sizing of template for installation but we do request that it is double checked prior to marking and cutting of vehicle fender. Failure to follow instructions may result in a poor fitting component or damage to fender.

**Important Template information:**

On PDF Print screen, chose option  Do Not Scale  or  Actual Size   
This will print the correctly sized template. Correct template measurements are supplied for reference.

(Template length - Length 8 3/4" , Width 2 1/8")

(Cut Out Location - Length 5 1/4" , Width 1 1/8")

Questions regarding template printing please call:  
(770) - 614-6101 (Attn: Tech Department)

Snorkel system has been designed to reduce possible hydro locking caused by water entering intake system. The system is designed to provide dry, clean air to the engine and should not be used to exceed manufactures recommended fording depth. Proper off road driving technics should be used when fording any type of legal water crossing. It is the owners responsibility to judge conditions prior to placing vehicle in a situation where water intake is possible. The system should be used as a safeguard and not a full 100% sealed intake sytem. Rugged Ridge / Omix-Ada Inc. is not responsible for damages caused by improper installation an or use of snorkel system. System should be cleaned and flushed annually. Drain should be inspected and water expelled on a regular basis.

Manufactures warranty covers only products supplied by Rugged Ridge / Omix - Ada Inc.

Omix-Ada Inc.  
460 Horizon Dr. Suite 400  
Suwanee, Georgia 30024