



OMIX-ADA, Inc.

Part #11425.10
11425.12

460 HORIZON DR. SUITE 100 | SUWANEE, GA 30024 | PHONE: 770-614-6101 | FAX: 770-614-6069 | info@omix-ada.com

Elite Fuel Door

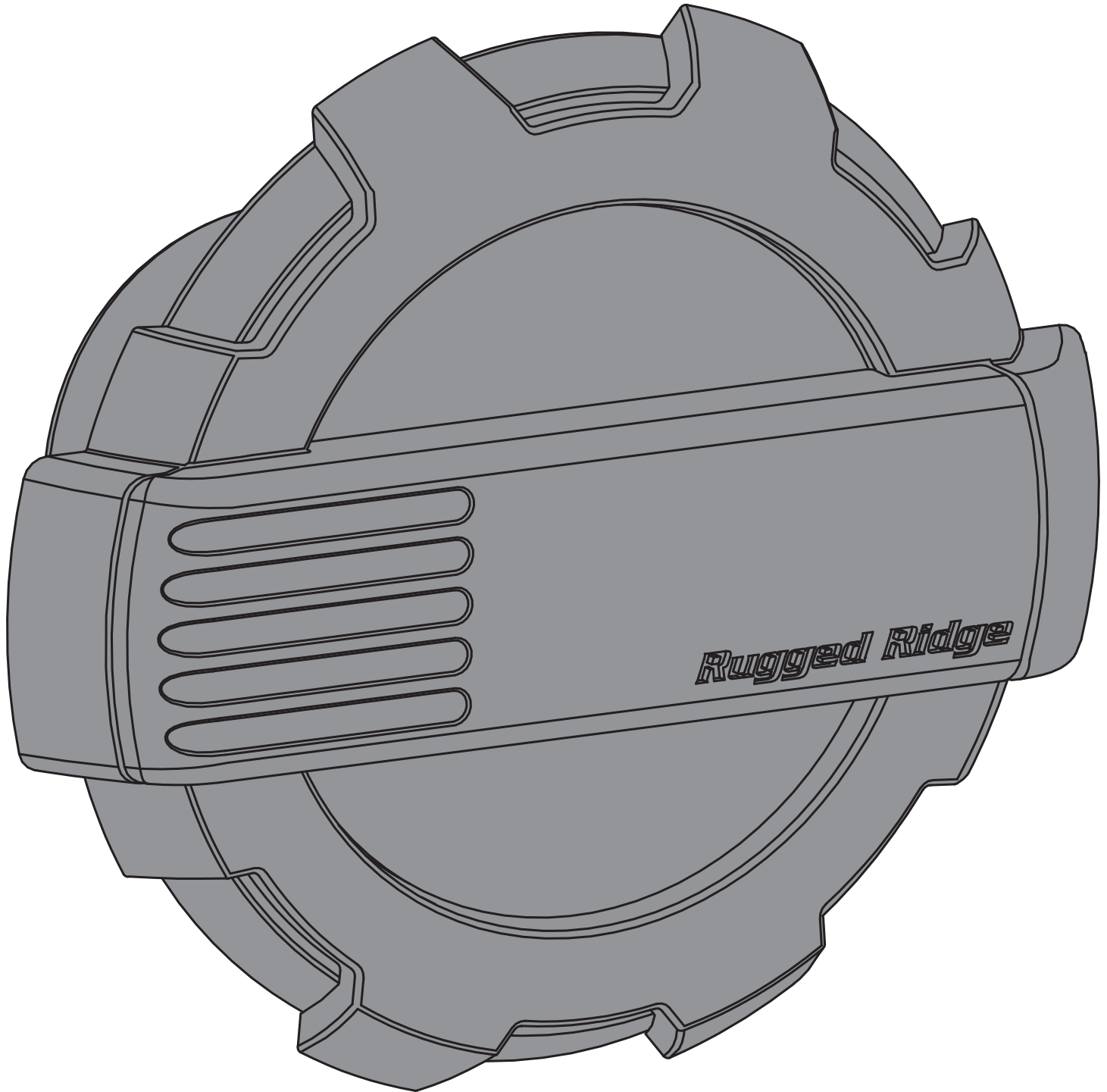

OMIX-ADA® TECHNICAL SUPPORT

PHONE: M-F 8am - 5pm EST 1-800-449-6649 | **EMAIL:** techsupport@omix-ada.com

FOR WARRANTY INFORMATION VISIT: www.Omix-Ada.com

Elite Fuel Door

1. Remove left taillight by unscrewing two phillips head screws.

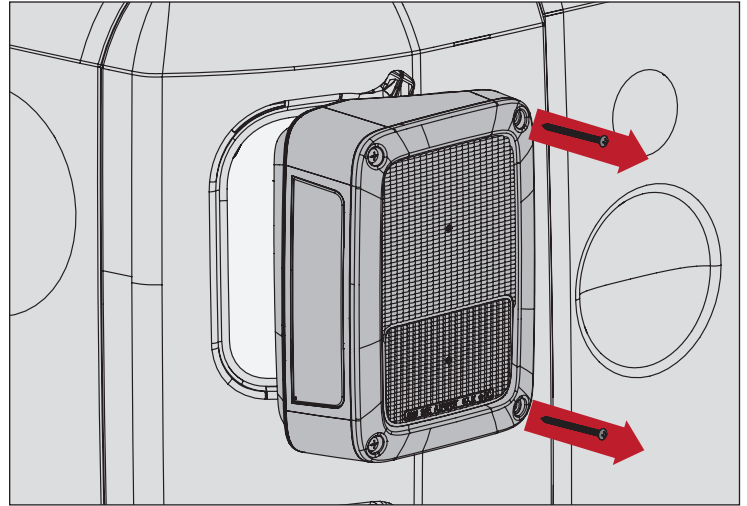

2. Disconnect taillight electrical socket. Push down on tab and pull connector apart.

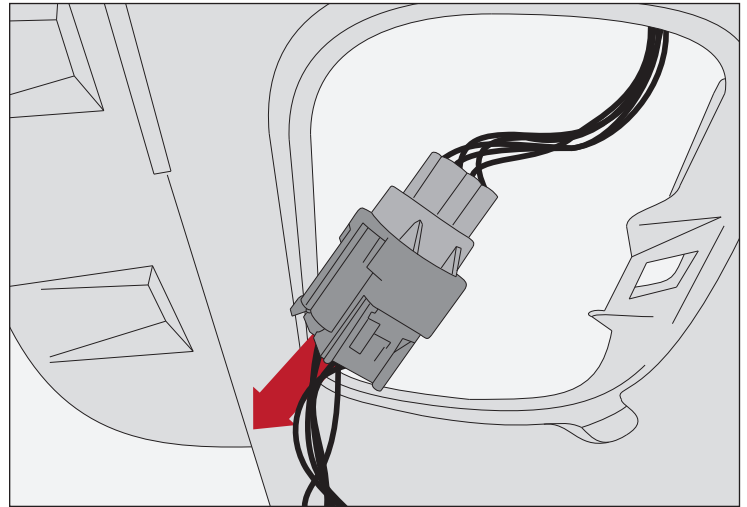

3. Remove gas cap. Pull gas cap tether from fuel filler housing and set gas cap aside.

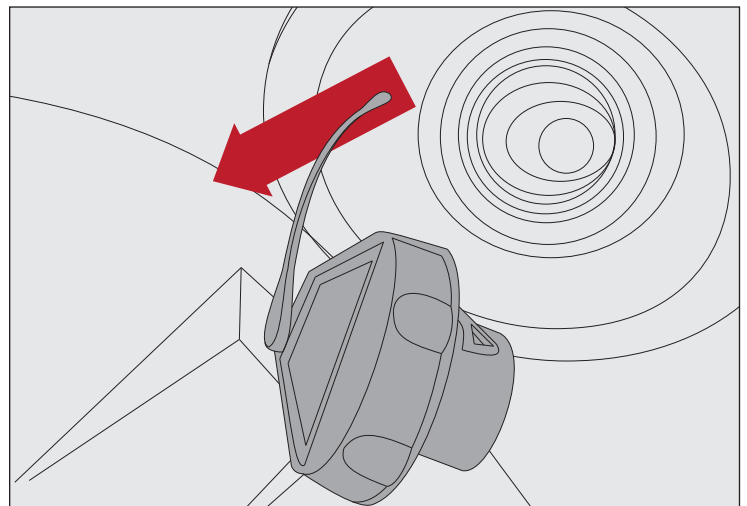

Elite Fuel Door

4. Remove OE fuel filler neck, by releasing plastic tabs on back of fuel neck. Pull fuel filler neck to remove. Clean area previously covered by filler housing before proceeding.

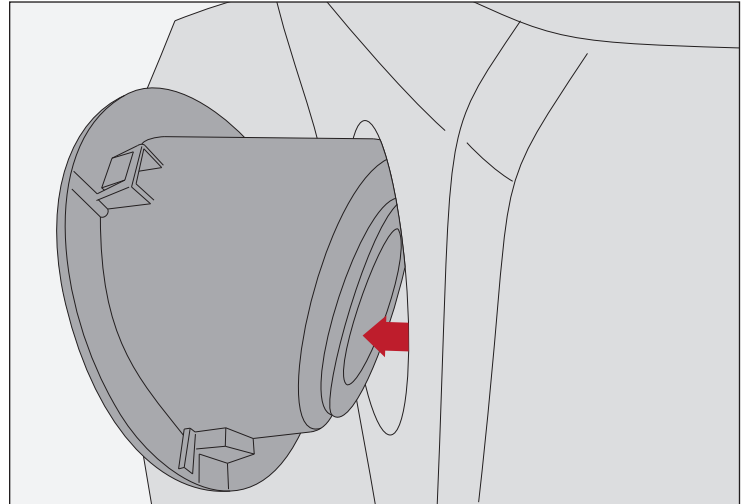

5. Align grommet on filler housing with fuel filler. Apply moderate pressure to front face of fuel door to engage.

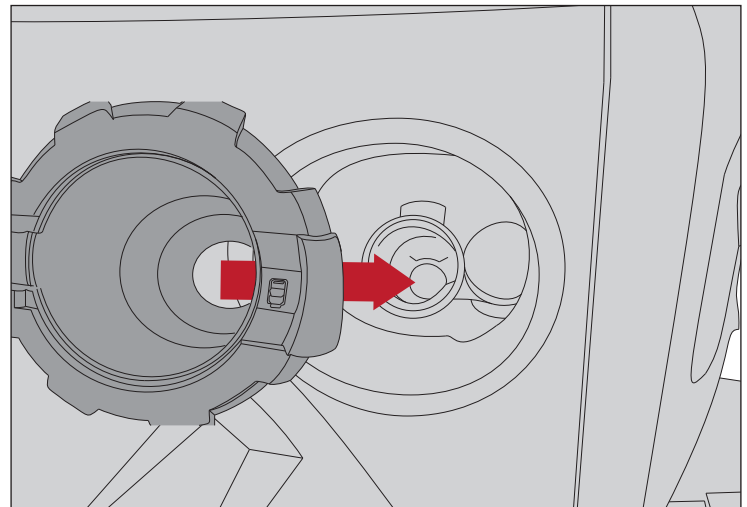

6. Reattach fuel door tether to Rugged Ridge Fuel Door filler housing.

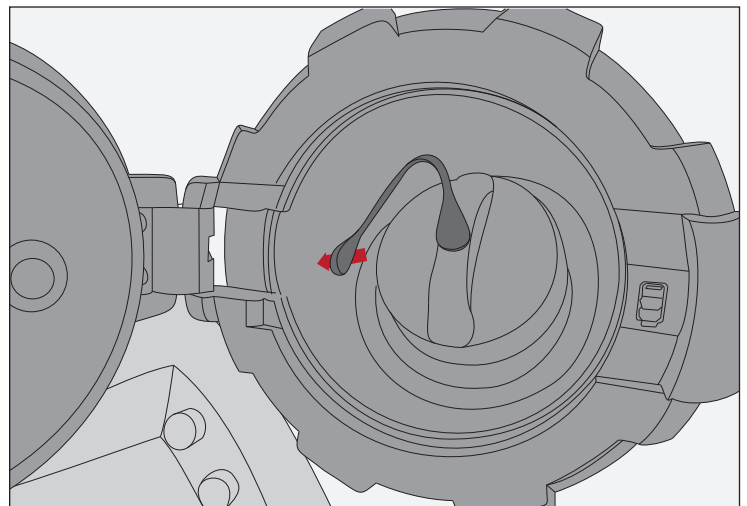

Elite Fuel Door

7. Reattach taillight electrical connectors and reinstall taillight.

